



# E62-3ph AND 3HF

## HEAVY DUTY THREE PHASE AC FILTER CAPACITORS



HIGH-END FOR THE HEART OF YOUR AC FILTER

**ELECTRONICON**<sup>®</sup>  
always in charge



Choose the best capacitor  
for any of your power electronics applications:

AC and DC capacitors with integrated safety mechanism  
E62 AC/DC E62-3ph AC Filter E63 DC

Low-inductance capacitors  
E50 PK16™ DC E53 AC/DC E61 DC

Low-inductance High-voltage capacitors  
E51

AC and DC capacitors with large capacitance  
E56 DC E59 AC/DC E70 AC E50.U SR17™ DC

CAPACITORS

**ELECTRONICON**®

*always in charge*

# **E62-3ph and 3HF: HEAVY DUTY THREE PHASE AC FILTER CAPACITORS**

DREIPHASIGE AC FILTER-KONDENSATOREN





## E62-3ph and 3HF High-End Capacitors for the Heart of your AC Filter

Our three-phase filter capacitors stand out by their high AC-voltage load capacity. They have been designed especially for heavy duty operation in extreme or sophisticated operating conditions, such as AC filtering and power factor correction in wind power and UPS applications, harmonic filtering in three-phase mains with high or unusual levels of harmonic distortion, a.m.o.

Thanks to their construction, they have a very low series resistance and a small self-inductance. Our basic design principle – preferring short winding elements with comparably large diameters – as well as the use of wavecut technology in many models, serves for high rms and surge current strength so important for all filter applications.

The three capacitor elements are connected in delta internally; the plant oil filling is environmentally friendly and serves for optimized heat dissipation and improved internal insulation. Many capacitors of the E62-3ph range are also available as completely dry option with nitrogen filling on request.

The finger-proof CAPAGRIP™ screw terminals of our E62-3ph series are rated IP20 and make for simple and reliable connections and easy addition of IP20-resistors or reactors for discharge.

Our new range E62-3HF is equipped with terminals optimized for the use in filters with very high harmonic frequencies of >1kHz.

The standard design has a long-term stable capacitance tolerance of  $\pm 5\%$ . Tighter tolerances are available on request.

Very good self-healing characteristics and the integrated overpressure protection (BAM™) ensure safe operation and controlled disconnection in the event of overload or failure at the end of operating life.

## E62-3ph und 3HF High-End Kondensatoren für Ihren WechselspannungsfILTER

Unsere dreiphasigen Filterkondensatoren zeichnen sich durch hohe Wechselspannungsbelastbarkeit und Stoßspannungsfestigkeit aus. Sie wurden speziell für die Verwendung unter komplizierten Betriebsbedingungen entwickelt, wie sie zum Beispiel bei der Oberwellenfilterung in Dreiphasennetzen und beim Einsatz in Windkraftanlagen und USV auftreten.

Dank ihrer speziellen Konstruktion weisen sie besonders niedrige Serienwiderstände und geringe Eigeninduktivität auf. Unser grundlegendes Designprinzip – vorzugsweise flache Wickel mit verhältnismäßig großem Durchmesser – sowie die in vielen Modellen eingesetzte Wellenschnitt-Technologie ermöglichen die in Filteranwendungen so wichtige Festigkeit gegenüber hohen Effektiv- und Stoßströmen.

Die drei Kondensatorelemente sind intern im Dreieck verschaltet. Die umweltfreundliche Füllung mit Pflanzenöl sorgt für optimierte Ableitung der Verlustwärme und verbesserte Isolation. Viele Typen der E62-3ph Reihe sind auf Anfrage auch als komplett trockene Ausführung mit Stickstofffüllung erhältlich.

Die berührungsgeschützten CAPAGRIP™-Anschlüsse unserer E62-3ph Reihe mit Schutzgrad IP20 erleichtern die Montage und ermöglichen das einfache Hinzufügen von IP20-Entladewiderständen oder -drosseln.

Unsere neue Baureihe E62-3HF ist mit Anschlusselementen ausgestattet, die für den Gebrauch in Filtern mit sehr hohen Oberwellen von >1kHz optimiert wurden.

In der Standardausführung beträgt die Kapazitätstoleranz  $\pm 5\%$ . Engere Toleranzen sind auf Anfrage möglich.

Für einen sicheren Schutz bei Überlastung bzw. einen kontrollierten Ausfall am Ende der Lebensdauer sorgen die sehr gute Selbstheilfähigkeit sowie ein in den Kondensatoren integrierter Überdruck-Unterbrecher (BAM™).



E62 - 3ph  
AC - Filter  
640...750V AC

for latest edition and updates  
check [www.powercapacitors.info](http://www.powercapacitors.info)

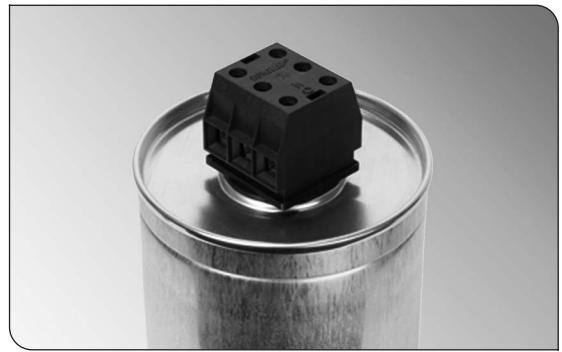

Three phase AC-Filter Capacitors  
Dreiphasige Wechselspannungs-Filterkondensatoren



- Standards .....IEC 61071  
optional IEC 61881  
optional IEC 60831  
UL810, CSA 22.2 No.190
- can Gehäuse .....aluminium Aluminium
- mounting position Einbaulage.....terminals pointing upwards stehend
- filling material .....liquid, based on vegetable oil, non-PCB  
optionally available with gas-filling
- Füllmittel.....flüssig, auf Pflanzenölbasis, PCB-frei  
optional auch mit Gasfüllung erhältlich
- Internal protection .....break-action mechanism (BAM)
- Interne Sicherung .....Überdrucksicherung
- fire load Brandlast .....40 MJ/kg
- C<sub>N</sub> tolerance Toleranz .....±5%
- tanδ<sub>0</sub> .....2 x 10<sup>-4</sup>

operating temperatures Grenztemperaturen  
 $\Theta_{min} \dots \Theta_{max}$  ..... -50 ... +85°C  
 $\Theta_{HOTSPOT}$  ..... ≤ 85°C

storing temperature Lagertemperatur ..... -50 ... +85°C

statistical lifetime statistische Lebensdauer ..>200 000 h  
 Failure rate Ausfallrate ..... 100 FIT  
(reference service life\_Referenzbetriebsdauer 100000 h,  $\Theta_{HOTSPOT} \leq 70^\circ\text{C}$ )

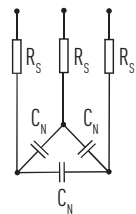

Principal circuit diagram\_Prinzipschaltbild



C <sub>N</sub> (μF)	R <sub>s</sub> (mΩ)	L <sub>e</sub> (nH)	R <sub>th</sub> (K/W)	I <sub>max</sub> (A)	I <sub>s</sub> (kA)	D <sub>1</sub> × L <sub>1</sub> (mm)	Design Maßbild	m (kg)	order no. Bestell-Nr.	pcs / box Stk / Box	
<b>U<sub>N</sub> 640V AC</b>		<b>U<sub>rms</sub> 450V</b>		<b>U<sub>s</sub> 1380V</b>		<b>U<sub>BB</sub> 1060V 50Hz AC / 2s</b>		<b>U<sub>BG</sub> 3600V 50Hz AC / 2s</b>			
3 × 24	3 × 1.5	110	6.3	3 × 16	0.67	2.01	60 × 151	D3	0.4	E62.K15-243D30	18 / FB7
3 × 33	3 × 1.2	90	4.7	3 × 56	0.9	2.7	75 × 164	L3	0.8	E62.M16-333L30	5 / FB8
3 × 40	3 × 1.2	130	4.7	3 × 56	1.1	3.3	75 × 164	L3	0.8	E62.M16-403L30	5 / FB8
3 × 46	3 × 1.1	110	4.1	3 × 56	1.3	3.9	85 × 164	L3	1	E62.N16-463L30	5 / FB8
3 × 51	3 × 1.1	140	4.1	3 × 56	1.4	4.2	85 × 164	L3	1	E62.N16-513L30	5 / FB8
3 × 57	3 × 0.8	120	3.7	3 × 56	1.6	4.8	95 × 164	L3	1.2	E62.P16-573L30	3 / FB8
3 × 68	3 × 0.5	120	3.7	3 × 56	1.9	5.7	95 × 164	L3	1.2	E62.P16-683L30	3 / FB8
3 × 80	3 × 0.5	100	3	3 × 56	2.6	7.8	116 × 164	L3	1.8	E62.R16-803L30	3 / FB8
3 × 100	3 × 0.4	100	3	3 × 56	3	9	116 × 164	L3	1.8	E62.R16-104L30	3 / FB8
3 × 135	3 × 0.55	120	2.1	3 × 80	2.5	7.5	116 × 230	M3	2.6	E62.R23-134M30	3 / FB9
3 × 200	3 × 0.55	125	1.8	3 × 80	3.5	10.5	136 × 230	M3	3.5	E62.S23-204M30	2 / FB12
<b>U<sub>N</sub> 750V AC</b>		<b>U<sub>rms</sub> 530V</b>		<b>U<sub>s</sub> 1610V</b>		<b>U<sub>BB</sub> 1250V 50Hz AC / 2s</b>		<b>U<sub>BG</sub> 3600V 50Hz AC / 2s</b>			
3 × 9	3 × 1.8	100	7.6	3 × 16	0.34	1.02	50 × 151	D3	0.3	E62.G15-902D30	21 / FB7
3 × 10	3 × 1.8	100	7.6	3 × 16	0.35	1.05	50 × 151	D3	0.3	E62.G15-103D30	21 / FB7
3 × 12	3 × 1.7	100	6.9	3 × 16	0.5	1.5	55 × 151	D3	0.35	E62.H15-123D30	18 / FB7
3 × 16	3 × 1.6	100	6.3	3 × 16	0.6	1.8	60 × 151	D3	0.4	E62.K15-163D30	18 / FB7

DATA CHARTS\_DATENTABELLEN\_E62 - 3ph

Other values and dimensions available on request.  
Andere Werte und Abmessungen auf Anfrage erhältlich.





E62 - 3ph  
AC - Filter  
750...1130V AC

$C_N$ ( $\mu$ F)	$R_S$ (m $\Omega$ )	$L_e$ (nH)	$R_{th}$ (K/W)	$I_{max}$ (A)	$\hat{I}$ (kA)	$I_S$ (kA)	$D_1 \times L_1$ (mm)	Design Maßbild	m (kg)	order no. Bestell-Nr.	pcs / box Stk / Bo $\times$
<b><math>U_N</math> 750V AC</b>		<b><math>U_{rms}</math> 530V</b>		<b><math>U_S</math> 1610V</b>		<b><math>U_{BB}</math> 1250V 50Hz AC / 2s</b>			<b><math>U_{BG}</math> 3600V 50Hz AC / 2s</b>		
3 $\times$ 23	3 $\times$ 1.2	100	4.7	3 $\times$ 56	0.86	2.58	75 $\times$ 164	L3	0.8	E62.M16-233L30	5 / FB8
3 $\times$ 29	3 $\times$ 1.2	130	4.1	3 $\times$ 56	1.1	3.3	85 $\times$ 164	L3	1	E62.N16-293L30	5 / FB8
3 $\times$ 30	3 $\times$ 1.2	120	4.1	3 $\times$ 56	1.1	3.3	85 $\times$ 164	L3	1	E62.N16-303L30	5 / FB8
3 $\times$ 38.4	3 $\times$ 0.65	120	3.7	3 $\times$ 56	1.4	4.2	95 $\times$ 164	L3	1.2	E62.P16-383L30	3 / FB8
3 $\times$ 48	3 $\times$ 0.75	100	3.1	3 $\times$ 56	1.8	5.4	100 $\times$ 164	L3	1.4	E62.Q16-483L30	3 / FB9
3 $\times$ 100	3 $\times$ 0.6	120	2.1	3 $\times$ 80	2.1	6.3	116 $\times$ 230	M3	2.6	E62.R23-104M30	3 / FB9
<b><math>U_N</math> 850V AC</b>		<b><math>U_{rms}</math> 600V</b>		<b><math>U_S</math> 1830V</b>		<b><math>U_{BB}</math> 1420V 50Hz AC / 2s</b>			<b><math>U_{BG}</math> 4800V 50Hz AC / 2s</b>		
3 $\times$ 6	3 $\times$ 2	100	7.6	3 $\times$ 16	0.25	0.75	50 $\times$ 151	D3	0.3	E62.G15-602D30	21 / FB7
3 $\times$ 6.7	3 $\times$ 2	100	7.6	3 $\times$ 16	0.3	0.9	50 $\times$ 151	D3	0.3	E62.G15-672D30	21 / FB7
3 $\times$ 9	3 $\times$ 1.7	100	6.3	3 $\times$ 16	0.8	2.4	60 $\times$ 151	D3	0.4	E62.K15-902D30	18 / FB7
3 $\times$ 14	3 $\times$ 1.3	130	4.7	3 $\times$ 56	0.6	1.8	75 $\times$ 164	L3	0.8	E62.M16-143L30	5 / FB8
3 $\times$ 19	3 $\times$ 0.75	100	4.1	3 $\times$ 56	1.6	4.8	85 $\times$ 164	L3	1	E62.N16-193L30	5 / FB8
3 $\times$ 25	3 $\times$ 0.6	100	3.7	3 $\times$ 56	2.2	6.6	95 $\times$ 164	L3	1.2	E62.P16-253L30	3 / FB8
3 $\times$ 30	3 $\times$ 0.5	120	3.5	3 $\times$ 56	2.6	7.8	100 $\times$ 164	L3	1.5	E62.Q16-303L30	3 / FB8
3 $\times$ 37.5	3 $\times$ 0.5	130	2.9	3 $\times$ 56	2.6	7.8	100 $\times$ 196	L3	1.6	E62.Q19-383L30	3 / FB8
3 $\times$ 50	3 $\times$ 0.65	130	2.5	3 $\times$ 56	2.4	7.2	100 $\times$ 230	L3	2.0	E62.Q23-503L30	3 / FB9
3 $\times$ 86	3 $\times$ 0.6	130	1.8	3 $\times$ 56	4.4	13.2	136 $\times$ 230	L3	3.5	E62.S23-863L30	2 / FB9
<b><math>U_N</math> 1080V AC</b>		<b><math>U_{rms}</math> 760V</b>		<b><math>U_S</math> 2320V</b>		<b><math>U_{BB}</math> 1800V 50Hz AC / 2s</b>			<b><math>U_{BG}</math> 4800V 50Hz AC / 2s</b>		
3 $\times$ 4.7	3 $\times$ 1.8	100	7.6	3 $\times$ 16	0.5	1.5	50 $\times$ 151	D3	0.3	E62.G15-472D30	21 / FB7
3 $\times$ 5	3 $\times$ 1.6	100	6.9	3 $\times$ 16	0.55	1.65	55 $\times$ 151	D3	0.35	E62.H15-502D30	18 / FB7
3 $\times$ 6.2	3 $\times$ 1.2	120	4.7	3 $\times$ 56	0.9	2.7	75 $\times$ 164	L3	0.8	E62.M16-622L30	5 / FB8
3 $\times$ 7.3	3 $\times$ 1.7	100	6.3	3 $\times$ 16	0.8	2.4	60 $\times$ 151	D3	0.4	E62.K15-732D30	18 / FB7
3 $\times$ 9.7	3 $\times$ 1.2	120	4.7	3 $\times$ 56	1.1	3.3	75 $\times$ 164	L3	0.8	E62.M16-972L30	5 / FB8
3 $\times$ 11	3 $\times$ 1.1	120	4.7	3 $\times$ 56	1.2	3.6	75 $\times$ 164	L3	0.8	E62.M16-113L30	5 / FB8
3 $\times$ 16.7	3 $\times$ 0.5	130	3.7	3 $\times$ 56	1.9	5.7	95 $\times$ 164	L3	1.2	E62.P16-173L30	3 / FB8
3 $\times$ 18.4	3 $\times$ 0.5	110	3.7	3 $\times$ 56	2	6	95 $\times$ 164	L3	1.2	E62.P16-183L30	3 / FB8
3 $\times$ 22	3 $\times$ 0.6	120	3.5	3 $\times$ 56	2.5	7.5	100 $\times$ 164	L3	1.5	E62.Q16-223L30	3 / FB8
3 $\times$ 27.6	3 $\times$ 0.4	120	3	3 $\times$ 56	3.1	9.3	116 $\times$ 164	L3	1.8	E62.R16-283L30	3 / FB8
3 $\times$ 33.4	3 $\times$ 0.9	140	2.6	3 $\times$ 56	2.0	6.0	95 $\times$ 230	L3	1.8	E62.P23-333L30	3 / FB9
3 $\times$ 55.7	3 $\times$ 0.4	130	2.1	3 $\times$ 56	5	15	136 $\times$ 196	L3	2.8	E62.S19-563L30	2 / FB9
<b><math>U_N</math> 1130V AC</b>		<b><math>U_{rms}</math> 800V</b>		<b><math>U_S</math> 2430V</b>		<b><math>U_{BB}</math> 1890V 50Hz AC / 2s</b>			<b><math>U_{BG}</math> 4800V 50Hz AC / 2s</b>		
3 $\times$ 24.9	3 $\times$ 0.55	140	2.9	3 $\times$ 56	2.2	6.6	100 $\times$ 196	L3	1.6	E62.Q19-253L30	3 / FB9
3 $\times$ 33.2	3 $\times$ 0.52	130	2.5	3 $\times$ 56	2.9	8.7	116 $\times$ 196	L3	2.2	E62.R19-333L30	3 / FB9
3 $\times$ 41.4	3 $\times$ 0.5	130	2.1	3 $\times$ 56	3.7	11	136 $\times$ 196	L3	3	E62.S19-413L30	2 / FB9
3 $\times$ 46.5	3 $\times$ 0.5	130	2.1	3 $\times$ 56	4	12	136 $\times$ 196	L3	3	E62.S19-463L30	2 / FB9
3 $\times$ 49	3 $\times$ 0.55	120	2.1	3 $\times$ 56	3.2	9.6	116 $\times$ 230	L3	2.5	E62.R23-493L30	3 / FB9



E62 - 3ph  
AC - Filter  
1200...1700V AC



$C_N$ ( $\mu$ F)	$R_S$ (m $\Omega$ )	$L_e$ (nH)	$R_{th}$ (K/W)	$I_{max}$ (A)	$\hat{I}$ (kA)	$I_s$ (kA)	$D_1 \times L_1$ (mm)	Design Maßbild	m (kg)	order no. Bestell-Nr.	pcs / box Stk / Box
<b><math>U_N</math> 1200V AC</b>		<b><math>U_{rms}</math> 850V</b>		<b><math>U_s</math> 2580V</b>		<b><math>U_{BB}</math> 2010V 50Hz AC / 2s</b>			<b><math>U_{BG}</math> 4800V 50Hz AC / 2s</b>		
3 × 2.5	3 × 1.8	100	7.6	3 × 16	0.33	1	50 × 151	D3	0.3	E62.G15-252D30	21 / FB7
3 × 3	3 × 1.7	100	7.6	3 × 16	0.43	1.3	50 × 151	D3	0.3	E62.G15-302D30	21 / FB7
3 × 4	3 × 1.6	100	7.6	3 × 16	0.5	1.5	50 × 151	D3	0.3	E62.G15-402D30	21 / FB7
3 × 8	3 × 1.3	120	4.7	3 × 56	1	3	75 × 164	L3	0.8	E62.M16-802L30	5 / FB8
3 × 12	3 × 1.1	120	4.1	3 × 56	1.5	4.5	85 × 164	L3	1.0	E62.N16-123L30	5 / FB8
3 × 23	3 × 0.5	110	3	3 × 56	2.8	8.4	116 × 164	L3	1.8	E62.R16-233L30	3 / FB8
3 × 25	3 × 0.4	130	3	3 × 56	2.8	8.4	116 × 164	L3	1.8	E62.R16-253L30	3 / FB8
3 × 41.5	3 × 0.5	130	2.0	3 × 56	2.8	8.4	116 × 230	L3	3	E62.R23-413L30	3 / FB12
3 × 50	3 × 0.5	125	1.8	3 × 56	3.6	10.8	136 × 230	L3	3.4	E62.S23-503L30	2 / FB9
3 × 55.7	3 × 0.45	125	1.8	3 × 80	4	12	136 × 230	M3	3.5	E62.S23-563M30	2 / FB9
<b><math>U_N</math> 1400V AC</b>		<b><math>U_{rms}</math> 1000V</b>		<b><math>U_s</math> 3010V</b>		<b><math>U_{BB}</math> 2370V 50Hz AC / 2s</b>			<b><math>U_{BG}</math> 4800V 50Hz AC / 2s</b>		
3 × 11	3 × 0.45	130	3	3 × 56	2	6	116 × 164	L3	2.1	E62.R16-113L30	3 / FB8
3 × 20	3 × 0.6	120	2.1	3 × 56	1.8	5.4	116 × 230	L3	2.5	E62.R23-203L30	3 / FB9
3 × 33	3 × 0.55	120	1.8	3 × 56	3	9	136 × 230	L3	3.4	E62.S23-333L30	2 / FB9
3 × 40	3 × 0.65	140	1.5	3 × 56	2.8	8.4	136 × 280	L3	4.3	E62.S28-403L30	2 / FB10
<b><math>U_N</math> 1700V AC</b>		<b><math>U_{rms}</math> 1200V</b>		<b><math>U_s</math> 3660V</b>		<b><math>U_{BB}</math> 2840V 50Hz AC / 2s</b>			<b><math>U_{BG}</math> 4800V 50Hz AC / 2s</b>		
3 × 12	3 × 1	140	2.6	3 × 56	1.3	3.9	95 × 230	L3	1.8	E62.P23-123L30	3 / FB9
3 × 22	3 × 0.6	120	1.8	3 × 56	2.3	6.9	136 × 230	L3	3.4	E62.S23-223L30	2 / FB9





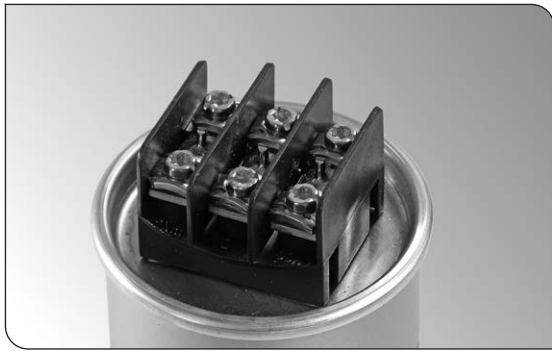

for latest edition and updates  
check [www.powercapacitors.info](http://www.powercapacitors.info)

**E62 - 3HF**  
High Frequency  
**640V AC**

**Three phase AC Capacitors for High Filter Frequencies**  
Dreiphasige Wechselspannungs-Kondensatoren  
für hohe Filterfrequenzen



- Standards** ..... IEC 61071  
optional IEC 61881  
optional IEC 60831  
UL810, CSA 22.2 No.190
- can Gehäuse** ..... aluminium Aluminium
- mounting position Einbaulage**... terminals pointing upwards stehend
- filling material** ..... liquid, based on vegetable oil, non-PCB
- Füllmittel**..... flüssig, auf Pflanzenölbasis, PCB-frei
- Internal protection** ..... break-action mechanism (BAM)
- Interne Sicherung** ..... Überdrucksicherung
- fire load Brandlast** ..... 40 MJ/kg
- C<sub>N</sub> tolerance Toleranz** ..... ±5%
- tanδ<sub>0</sub>** ..... 2 x 10<sup>-4</sup>

- operating temperatures Grenztemperaturen**  
 $\Theta_{min} \dots \Theta_{max}$  ..... -50 ... +85°C  
 $\Theta_{HOTSPOT}$  ..... ≤ 85°C
- storing temperature Lagertemperatur** ..... -50 ... +85°C
- statistical lifetime statistische Lebensdauer** ..>200 000 h
- Failure rate Ausfallrate** ..... 100 FIT  
(reference service life\_Referenzbetriebsdauer 100000 h,  $\Theta_{HOTSPOT} \leq 70^\circ\text{C}$ )

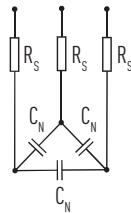

Principal circuit diagram\_Prinzipschaltbild

C <sub>N</sub> (μF)	R <sub>s</sub> (mΩ)	L <sub>e</sub> (nH)	R <sub>th</sub> (K/W)	I <sub>max</sub> (A)	I <sub>h</sub> (kA)	I <sub>s</sub> (kA)	D <sub>1</sub> × L <sub>1</sub> (mm)	Design Maßbild	m (kg)	order no. Bestell-Nr.	pcs / box Stk / Bo×
<b>U<sub>N</sub> 640V AC</b>			<b>U<sub>rms</sub> 450V</b>			<b>U<sub>s</sub> 1380V</b>		<b>U<sub>BB</sub> 1060V 50Hz AC / 2s</b>		<b>U<sub>BG</sub> 3600V 50Hz AC / 2s</b>	
3 × 33	3 × 0.9	110	4.7	3 × 39	0.9	2.7	75 × 164	S4	0.8	E62.M16-333S40	5 / FB8
3 × 40	3 × 0.5	110	4.7	3 × 39	1.1	3.3	75 × 164	S4	0.8	E62.M16-403S40	5 / FB8
3 × 46	3 × 0.5	120	4.1	3 × 56	1.3	3.9	85 × 164	S4	1.0	E62.N16-463S40	5 / FB8
3 × 51	3 × 0.5	120	4.1	3 × 56	1.4	4.2	85 × 164	S4	1.0	E62.N16-513S40	5 / FB8
3 × 68	3 × 0.5	120	3.7	3 × 56	2	6	95 × 164	S4	1.2	E62.P16-683S40	3 / FB8
3 × 80	3 × 0.7	130	3.1	3 × 56	1.8	5.4	95 × 196	S4	1.5	E62.P19-803S40	3 / FB9
3 × 100	3 × 0.4	100	3	3 × 56	2.8	8.4	116 × 164	S4	1.8	E62.R16-104S40	3 / FB8
3 × 100	3 × 0.4	100	3	3 × 100	2.8	8.4	116 × 164	MB	1.8	E62.R16-104MBO	3 / FB8
3 × 135	3 × 0.6	120	2.1	3 × 100	2.5	7.5	116 × 230	MB	2.5	E62.R23-134MBO	3 / FB9
3 × 140	3 × 0.5	120	2.1	3 × 56	2.5	7.5	116 × 230	S4	2.6	E62.R23-144S40	3 / FB9
3 × 200	3 × 0.5	120	1.8	3 × 100	3.4	10.2	136 × 230	MB	3.5	E62.S23-204MBO	2 / FB9



E62 - 3HF  
High Frequency  
750...1130V AC



$C_N$ ( $\mu$ F)	$R_S$ (m $\Omega$ )	$L_e$ (nH)	$R_{th}$ (K/W)	$I_{max}$ (A)	$\hat{I}$ (kA)	$I_s$ (kA)	$D_1 \times L_1$ (mm)	Design Maßbild	m (kg)	order no. Bestell-Nr.	pcs / box Stk / Bo×
<b><math>U_N</math> 750V AC</b>		<b><math>U_{rms}</math> 530V</b>		<b><math>U_s</math> 1610V</b>		<b><math>U_{BB}</math> 1250V 50Hz AC / 2s</b>			<b><math>U_{BG}</math> 3600V 50Hz AC / 2s</b>		
3 × 16	3 × 0.9	100	5.4	3 × 39	0.6	1.8	65 × 164	Z3	0.6	E62.L16-163Z30	10 / FB8
3 × 23	3 × 0.5	110	4.7	3 × 39	0.85	2.5	75 × 164	S4	0.8	E62.M16-233S40	5 / FB8
3 × 30	3 × 0.7	120	4.1	3 × 56	1.1	3.3	85 × 164	S4	1	E62.N16-303S40	5 / FB8
3 × 38.4	3 × 0.7	125	3.7	3 × 56	1.4	4.2	95 × 164	S4	1.2	E62.P16-383S40	3 / FB8
3 × 48	3 × 0.5	130	3.5	3 × 56	1.7	5.1	100 × 164	S4	1.4	E62.Q16-483S40	3 / FB9
3 × 75	3 × 0.6	130	2.5	3 × 56	2.2	6.6	116 × 196	S4	2.2	E62.R19-753S40	3 / FB9
3 × 100	3 × 0.6	120	2.1	3 × 56	2.2	6.6	116 × 230	S4	2.5	E62.R23-104S40	3 / FB9
3 × 100	3 × 0.6	120	2.1	3 × 100	2.2	6.6	116 × 230	MB	2.5	E62.R23-104MBO	3 / FB9
<b><math>U_N</math> 850V AC</b>		<b><math>U_{rms}</math> 600V</b>		<b><math>U_s</math> 1830V</b>		<b><math>U_{BB}</math> 1420V 50Hz AC / 2s</b>			<b><math>U_{BG}</math> 4800V 50Hz AC / 2s</b>		
3 × 9	3 × 0.8	100	5.8	3 × 39	0.8	2.4	60 × 164	Z3	0.5	E62.K16-902Z30	10 / FB8
3 × 11	3 × 0.9	100	5.4	3 × 39	1	3	65 × 164	Z3	0.6	E62.L16-113Z30	10 / FB8
3 × 12	3 × 0.9	100	5.4	3 × 39	1.1	3.3	65 × 164	Z3	0.6	E62.L16-123Z30	10 / FB8
3 × 14	3 × 0.5	120	4.7	3 × 39	1.2	3.6	75 × 164	S4	0.8	E62.M16-143S40	5 / FB8
3 × 19	3 × 0.5	120	4.1	3 × 56	1.7	5.1	85 × 164	S4	1	E62.N16-193S40	5 / FB8
3 × 25	3 × 0.6	120	3.7	3 × 56	2.2	6.6	95 × 164	S4	1.2	E62.P16-253S40	3 / FB8
3 × 30	3 × 0.5	120	3.5	3 × 56	2.6	7.8	100 × 164	S4	1.5	E62.P16-303S40	3 / FB8
3 × 37.5	3 × 0.4	130	2.9	3 × 56	2.7	8	100 × 196	S4	1.6	E62.Q19-373S40	3 / FB9
3 × 50	3 × 0.5	130	2.5	3 × 56	3.4	10.2	116 × 196	S4	2.2	E62.R19-503S40	3 / FB9
3 × 72.5	3 × 0.7	120	2.1	3 × 56	3.7	11.1	116 × 230	S4	2.6	E62.R23-723S40	3 / FB9
3 × 100	3 × 0.5	130	1.8	3 × 100	5	15	136 × 230	MB	3.5	E62.S23-104MBO	2 / FB9
<b><math>U_N</math> 1080V AC</b>		<b><math>U_{rms}</math> 760V</b>		<b><math>U_s</math> 2320V</b>		<b><math>U_{BB}</math> 1800V 50Hz AC / 2s</b>			<b><math>U_{BG}</math> 4800V 50Hz AC / 2s</b>		
3 × 11	3 × 1	110	4.7	3 × 39	1.2	3.6	75 × 164	S4	0.8	E62.M16-113S40	5 / FB8
3 × 18.4	3 × 0.5	125	3.7	3 × 56	1.9	5.7	95 × 164	S4	1.2	E62.P16-183S40	3 / FB8
3 × 22	3 × 0.5	130	3.1	3 × 56	2	6	95 × 196	S4	1.5	E62.P19-223S40	3 / FB9
3 × 27.6	3 × 0.4	120	3	3 × 56	3.1	9.3	116 × 164	S4	1.8	E62.R16-283S40	3 / FB8
3 × 33.4	3 × 0.6	130	2.6	3 × 56	2	6	95 × 230	S4	1.7	E62.P23-333S40	3 / FB9
3 × 49	3 × 0.55	120	2.1	3 × 56	3.2	9.6	116 × 230	S4	2.7	E62.R23-493S40	3 / FB9
3 × 55.7	3 × 0.4	130	2.1	3 × 56	5	15	136 × 196	S4	3	E62.S19-563S40	2 / FB9
3 × 55.7	3 × 0.4	130	2.1	3 × 100	5	15	136 × 196	MB	3	E62.S19-563MBO	2 / FB9
3 × 75	3 × 0.5	130	1.8	3 × 100	4.5	13.5	136 × 230	MB	3.5	E62.S23-753MBO	2 / FB9
<b><math>U_N</math> 1130V AC</b>		<b><math>U_{rms}</math> 800V</b>		<b><math>U_s</math> 2430V</b>		<b><math>U_{BB}</math> 1890V 50Hz AC / 2s</b>			<b><math>U_{BG}</math> 4800V 50Hz AC / 2s</b>		
3 × 24.9	3 × 0.6	130	2.9	3 × 56	2.2	6.6	100 × 196	S4	1.6	E62.Q19-253S40	3 / FB9
3 × 33.2	3 × 0.6	130	2.5	3 × 56	2.9	8.7	116 × 196	S4	2.2	E62.R19-333S40	3 / FB9
3 × 41.4	3 × 0.5	130	2.1	3 × 56	4.1	12.3	136 × 196	S4	3	E62.S19-413S40	3 / FB9
3 × 46	3 × 0.65	120	2.1	3 × 56	2.9	8.7	116 × 230	S4	2.6	E62.R23-463S40	3 / FB9

Other values and dimensions available on request.  
Andere Werte und Abmessungen auf Anfrage erhältlich.



E62 - 3HF  
High Frequency  
1200...1400V AC

$C_N$ ( $\mu\text{F}$ )	$R_S$ ( $\text{m}\Omega$ )	$L_e$ ( $\text{nH}$ )	$R_{th}$ ( $\text{K/W}$ )	$I_{\text{max}}$ ( $\text{A}$ )	$\hat{I}$ ( $\text{kA}$ )	$I_S$ ( $\text{kA}$ )	$D_1 \times L_1$ ( $\text{mm}$ )	Design Maßbild	m ( $\text{kg}$ )	order no. Bestell-Nr.	pcs / box Stk / Bo×
<b><math>U_N</math> 1200V AC</b>		<b><math>U_{\text{rms}}</math> 850V</b>		<b><math>U_S</math> 2580V</b>		<b><math>U_{\text{BB}}</math> 2010V 50Hz AC / 2s</b>			<b><math>U_{\text{BG}}</math> 4800V 50Hz AC / 2s</b>		
3 × 8	3 × 1	110	4.7	3 × 39	1	3	75 × 164	S4	0.8	E62.M16-802S40	5 / FB8
3 × 25	3 × 0.4	130	3	3 × 56	3.2	9.6	116 × 164	S4	2.2	E62.R16-253S40	3 / FB9
3 × 37.5	3 × 0.55	120	2.1	3 × 56	2.9	8.7	116 × 230	S4	2.6	E62.R23-373S40	3 / FB9
3 × 41.5	3 × 0.55	120	2.1	3 × 56	3	9	116 × 230	S4	2.6	E62.R23-413S40	3 / FB12
3 × 41.5	3 × 0.6	130	2.0	3 × 100	2.6	7.8	116 × 245	MB	2.7	E62.R24-413MB0	3 / FB12
3 × 55.7	3 × 0.4	125	1.8	3 × 100	4	12	136 × 230	MB	3.5	E62.S23-563MB0	2 / FB9
<b><math>U_N</math> 1400V AC</b>		<b><math>U_{\text{rms}}</math> 1000V</b>		<b><math>U_S</math> 3000V</b>		<b><math>U_{\text{BB}}</math> 2370V 50Hz AC / 2s</b>			<b><math>U_{\text{BG}}</math> 4800V 50Hz AC / 2s</b>		
3 × 33	3 × 0.4	120	1.8	3 × 100	3.0	9.0	136 × 230	MB	3.5	E62.S23-333MB0	2 / FB9
3 × 40	3 × 0.55	150	1.5	3 × 100	2.8	8.4	136 × 280	MB	4.3	E62.S28-403MB0	2 / FB10



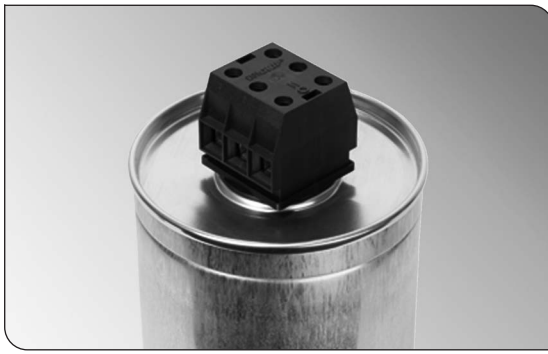

**Design L / M**  
**CAPAGRIP™**

L3/M3

Side view dimensions:  
 - Top diameter:  $D_1 + 5 \pm 1$   
 - Terminal height:  $h \pm 2$   
 - Total height:  $L_1$   
 - Mounting stud diameter: M12  
 - Stud height: 16  
 - Can diameter:  $D_1$

Top view dimensions:  
 - Terminal width:  $t$   
 - Terminal spacing:  $b$

**CAPACITORS WITH A CAN DIAMETER OF 75...136 mm**

Can material.....aluminium  
 Base mounting stud.....M12  
 Lid.....flanged aluminium (folded edge)  
 Humidity class.....C, TX (IEC 62498-1)  
 Degree of protection.....IP 20

**Terminal L3**

Contact..... $2 \times 25 \text{ mm}^2$ , M5, TORX T20  
 Torque.....2.5...3 Nm  
 $I_{\text{max}}$ .....56 A  
 K.....16 mm  
 L.....16 mm

**Terminal M3**

Contact..... $2 \times 50 \text{ mm}^2$ , M6, TORX T20  
 Torque.....3.2...3.7 Nm  
 $I_{\text{max}}$ .....104 A  
 K.....16 mm  
 L.....16 mm

**KONDENSATOREN MIT EINEM GEHÄUSEDURCHMESSER VON 75...136**

Gehäusematerial.....Aluminium  
 Bodenschraube.....M12  
 Deckel.....Aluminium, Bördelverschluss  
 Feuchtekategorie.....C, TX (IEC 62498-1)  
 Schutzgrad.....IP 20

**Anschluss L3**

Kontakte..... $2 \times 25 \text{ mm}^2$ , M5, TORX T20  
 Drehmoment.....2.5...3 Nm  
 $I_{\text{max}}$ .....56 A  
 K.....16 mm  
 L.....16 mm

**Anschluss M3**

Kontakte..... $2 \times 50 \text{ mm}^2$ , M6, TORX T20  
 Drehmoment.....3.2...3.7 Nm  
 $I_{\text{max}}$ .....104 A  
 K.....16 mm  
 L.....16 mm

	Design L3		Design M3	
	≤ Ø 100	≥ Ø 116	≤ Ø 100	≥ Ø 116
h	35	31	48	43
b	42	42	49	49
t	44	44	55	55





Design D3

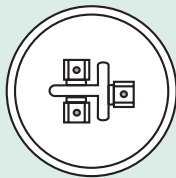
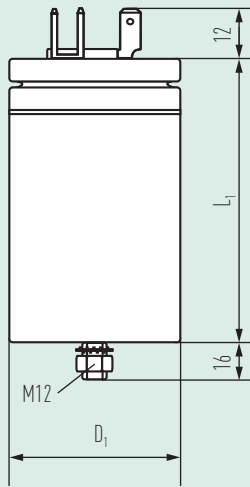

**CAPACITORS WITH A CAN DIAMETER OF 50...75 mm**

- Can material ..... aluminium
- Base mounting stud ..... M12
- Lid ..... plastic with rubber sealing, flanged can
- Terminals ..... dual tab connectors 6.3 x 0.8 mm  
(tinned brass, riveted)
- $I_{max}$  (Terminals) ..... 16 A
- Degree of protection ..... IP 00
- L ..... 7 mm
- K ..... 10 mm
- Humidity class ..... T1 (IEC 62498-1)

**KONDENSATOREN MIT EINEM GEHÄUSEDURCHMESSER VON 50...75**

- Gehäusematerial ..... Aluminium
- Bodenschraube ..... M12
- Deckel ..... Kunststoff, Bördelverschluss  
mit Gummidichtung
- Anschlüsse ..... Doppelflachstecker 6.3 x 0.8 mm  
(Messing, verzinkt, genietet)
- $I_{max}$  (Anschlüsse) ..... 16 A
- Schutzgrad ..... IP 00
- L ..... 7 mm
- K ..... 10 mm
- Feuchteklasse ..... T1 (IEC 62498-1)





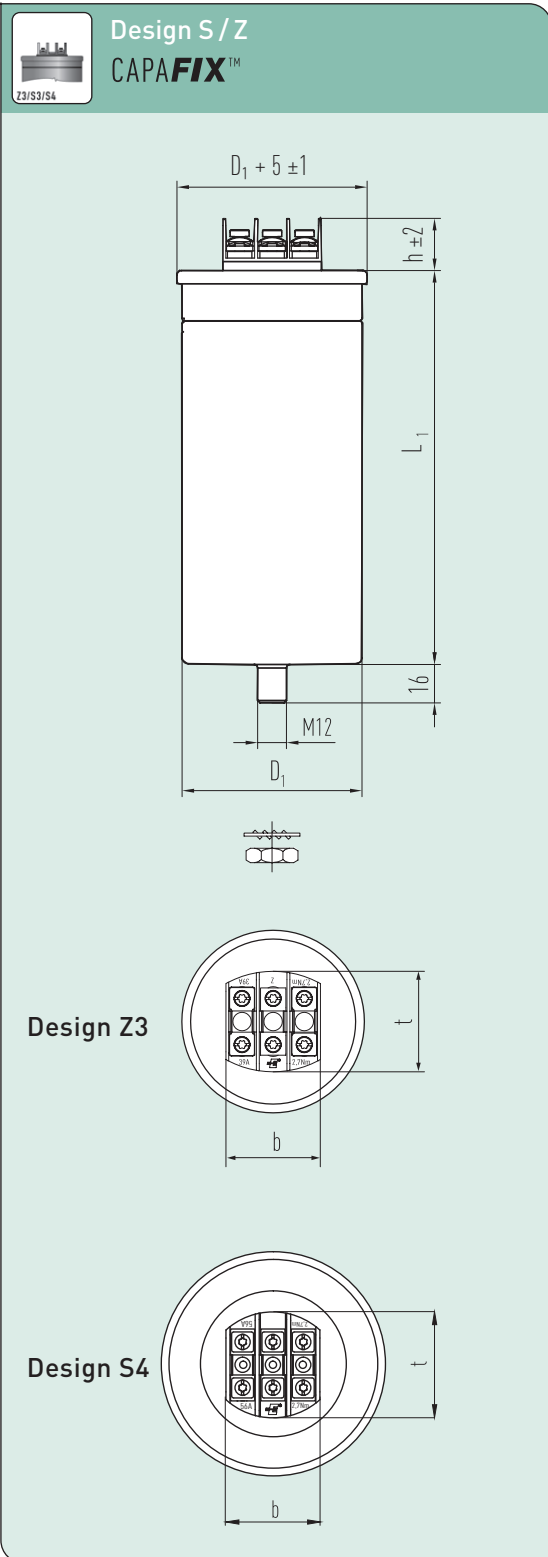
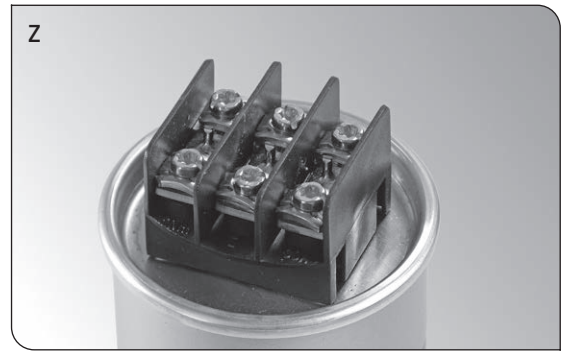
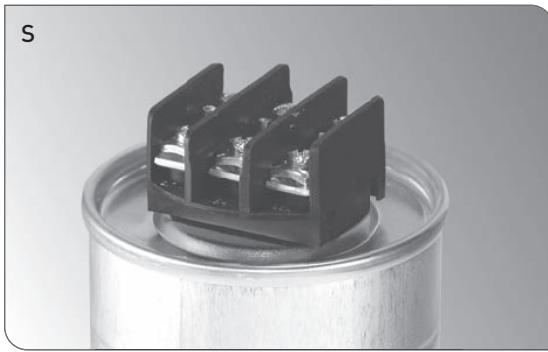

**CAPACITORS WITH A CAN DIAMETER OF 60...116 mm**

Can material.....aluminium  
 Base mounting stud .....M12  
 Lid flanged.....aluminium (folded edge)  
 Humidity class.....C, TX (IEC 62498-1)  
 Degree of protection .....IP 00

**Terminal Z3**

Contact.....2 × 10 mm<sup>2</sup>, M4 TORX T20  
 Torque.....2...2.7 Nm  
 I<sub>max</sub>.....39 A  
 K.....10 mm  
 L.....10 mm

**Terminal S4**

Contact.....2 × 16 mm<sup>2</sup>, M5 TORX T20  
 Torque.....3.7 ... 4 Nm  
 I<sub>max</sub>.....56 A  
 K.....11 mm  
 L.....11 mm

**KONDENSATOREN MIT EINEM GEHÄUSEDURCHMESSER VON 60...116 mm**

Gehäusematerial.....Aluminium  
 Bodenschraube.....M12  
 Deckel.....Aluminium, Bördelverschluss  
 Feuchtekategorie.....C, TX (IEC 62498-1)  
 Schutzgrad.....IP 00

**Anschluss Z3**

Kontakte.....2 x 10 mm<sup>2</sup>, M4 TORX T20  
 Drehmoment.....2...2.7 Nm  
 I<sub>max</sub>.....39 A  
 K.....10 mm  
 L.....10 mm

**Anschluss S4**

Kontakte.....2 × 16 mm<sup>2</sup>, M5 TORX T20  
 Drehmoment.....3.7 ... 4 Nm  
 I<sub>max</sub>.....56 A  
 K.....11 mm  
 L.....11 mm

	Design Z3	Design S4	
		≤ Ø 100	≥ Ø 116
h	22	23	18
b	41	47	47
t	43.5	53	35





Design MB

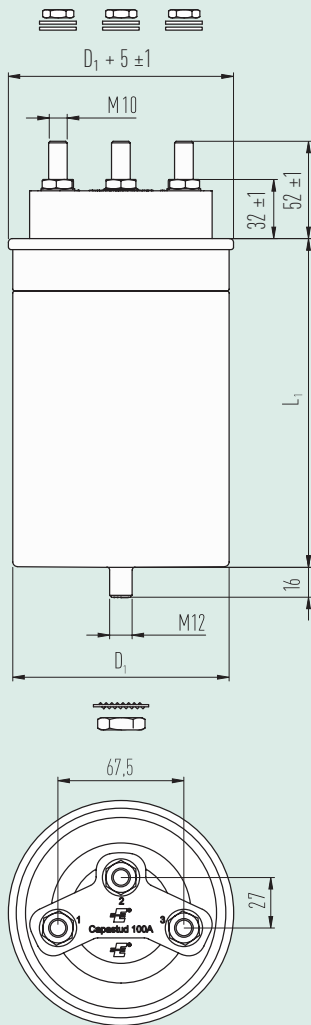

**CAPACITORS WITH A CAN DIAMETER OF 116/136 mm**

- Can material .....aluminium
- Base mounting stud ..... M12
- Lid ..... flanged aluminium (folded edge)
- Humidity class ..... C
- Degree of protection ..... IP 00
- Terminals .....brass stud M10
- Torque ..... 7.5...10 Nm
- $I_{max}$  (Terminals) ..... 100 A
- K ..... 25 mm
- L ..... 20 mm

**KONDENSATOREN MIT GEHÄUSEDURCHMESSER 116/136 mm**

- Gehäusematerial ..... Aluminium
- Bodenschraube ..... M12
- Deckel ..... Aluminium, Bördelverschluss
- Feuchtklasse ..... C
- Schutzgrad ..... IP 00
- Anschluss ..... Messingbolzen M10
- Drehmoment ..... 7.5...10 Nm
- $I_{max}$  (Anschlüsse) ..... 100 A
- K ..... 25 mm
- L ..... 20 mm



## ACCESSORIES ZUBEHÖR



### Protection Covers for CAPAFIX™ S and Z

Separate snap-on covers are available for terminals of the CAPAFIX™ series for protection of the operator from accidental contact. This kind of protection is comparable with IP10 (solid objects up to 50 mm, e.g. accidental touch by hands); however as the cover is removable without the aid of tools, IP rating does not apply.



### Schutzabdeckungen für CAPAFIX™ S und Z

Aufsnappbare Schutzabdeckungen sind separat für Kondensatoren mit CAPAFIX™ Anschlüssen erhältlich.

Sie dienen dem Schutz vor zufälliger Berührung, vergleichbar mit IP10 (feste Objekte bis 50 mm, Handrückenschutz); da die Abdeckung ohne Zuhilfenahme von Werkzeugen entfernbar ist, findet die IP-Klassifizierung jedoch keine Anwendung.

Order No. Bestell-Nr.

CAPAFIX™ S: 275.109-S40000

CAPAFIX™ Z: 275.109-Z00000

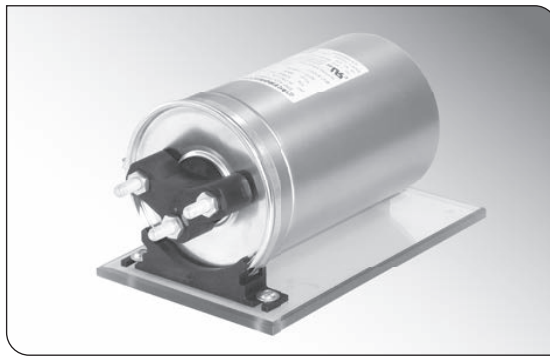

### Holder for Horizontal Mounting

Capacitors with diameter 136 mm can be mounted by means of this bracket on a flat vertical or horizontal surface. Please mind that a horizontal mounting position is recommended for gas-filled capacitors only. Oil-filled capacitors should be mounted in upright position only.

Use cables with good flexibility only to connect the capacitors in order to enable the function of the BAM.

The bracket is made of glass fibre reinforced polyamide and comes as a set including a matching 9 mm zinc-plated steel strap with screw thread for fixation of the capacitor.

### Halter für waagrechte Montage

Kondensatoren mit Durchmesser 136 mm können mit Hilfe dieser Schelle auf einer senkrechten oder waagerechten Oberfläche montiert werden. Es ist zu beachten, dass wir eine waagerechte Einbaulage nur für gasgefüllte Kondensatoren empfehlen. Ölgefüllte Kondensatoren sollten nur stehend montiert werden.

Um die Funktion der BAM-Sicherung zu gewährleisten, dürfen die Kondensatoren nur mit flexiblen Kabeln angeschlossen werden.

Der Halter ist aus glasfaserverstärktem Polyamid und wird inkl. passender 9 mm Schlauchschelle aus verzinktem Stahl mit Schneckengewinde für die Fixierung geliefert.

### Drawings Maßbilder

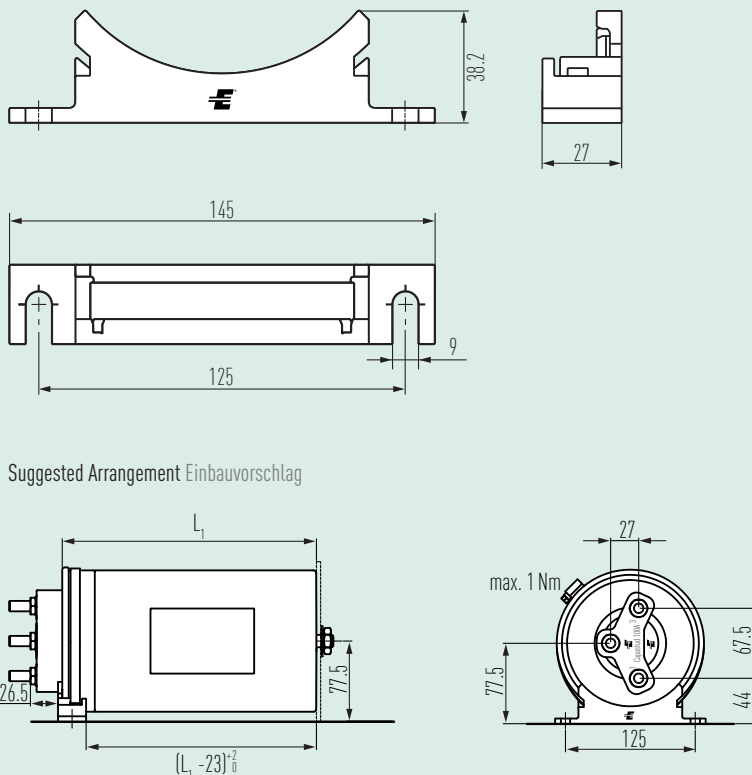

Order no. Bestellnr. ....E50.H36-100000



## Important Remarks

### General

Our catalogues outline the typical technical and mechanical characteristics of the listed capacitors. The stated values are based on reference type tests, as well as empirical and experimental experience. The real values of individual capacitors may differ within the stated, or commonly known, tolerances. Any information given in this catalogue therefore describes the components in general terms and does not constitute any guarantee of individual technical values.

It is the responsibility of the user to ensure by dedicated tests the suitability and safety of operation of our components under the conditions of his application. This also applies to any accessories offered by ELECTRONICON.

### Safety

Safe operation of the capacitors can be expected only if all safety recommendations as well as electrical and thermal specifications as stated on the label, in the data sheets, catalogues and the accompanying mounting instructions are strictly observed, and recommended safety devices are used as intended. Please consider the "General Safety Recommendations" of the power capacitor manufacturers organized in the German ZVEI ([www.electronicon.com/en/zvei](http://www.electronicon.com/en/zvei)).

The capacitors shall only be used for the intended application. ELECTRONICON will not indemnify or be responsible for any kind of damages to persons or property due to the improper application of any capacitors purchased from ELECTRONICON or its distributors.

Mind that electrical or mechanical misapplication of capacitors can become hazardous. Misapplied capacitors can explode or catch fire and cause bodily injury or property damage due to the expulsion of material or metal fragments.

Please consult the detailed instructions for mounting and application stated in our brochure „Application Notes“ and on the ELECTRONICON website: [www.electronicon.com/en/an](http://www.electronicon.com/en/an)

If in doubt about how to connect, operate, or discharge a capacitor, consult ELECTRONICON engineering or our distributors.

### Mounting And Cooling

The useful life of a capacitor may be reduced dramatically if exposed to excessive heat. Typically an increase in the ambient temperature of 7°C will halve the expected life of the capacitor. Make sure to obey the permitted operating temperatures.

To avoid overheating the capacitors must be allowed to cool unhindered and should be shielded from external heat sources. We recommend forced ventilation for all filter applications with reactors. Give approx. 20 mm clearance around capacitors for natural or forced ventilation, and do not place them directly above or next to heat sources such as detuning or tuning reactors, bus bars, etc.

## Wichtige Hinweise

### Allgemeines

Unsere Kataloge beschreiben die typischen technischen und mechanischen Eigenschaften der aufgeführten Kondensatoren. Die angegebenen Werte basieren auf Referenztypprüfungen sowie empirischen und experimentellen Erfahrungswerten. Die tatsächlichen Werte einzelner Kondensatoren können innerhalb der angegebenen bzw. allgemein bekannter Toleranzen abweichen. Alle Angaben in diesem Katalog beschreiben daher die Komponenten im Allgemeinen und stellen keine Garantie für individuelle technische Werte dar.

Es liegt in der Verantwortung des Anwenders, durch gezielte Prüfungen die Eignung und Betriebssicherheit unserer Komponenten unter den konkreten Betriebsbedingungen seiner Anwendung sicherzustellen. Dies gilt ebenso für gegebenenfalls von ELECTRONICON angebotene Zubehörteile.

### Sicherheit

Ein sicherer Betrieb der Kondensatoren ist nur zu erwarten, wenn alle Sicherheitsempfehlungen sowie elektrische und thermische Spezifikationen entsprechend Etikett, Datenblättern, Katalogen und beiliegenden Montageanleitungen eingehalten und die empfohlenen Sicherheitseinrichtungen bestimmungsgemäß verwendet werden. Bitte beachten Sie die „Allgemeinen Sicherheitsempfehlungen“ der im deutschen ZVEI organisierten Hersteller von Leistungskondensatoren ([www.electronicon.com/zvei](http://www.electronicon.com/zvei)).

Die Kondensatoren dürfen ausschließlich für ihren Bestimmungszweck verwendet werden. ELECTRONICON übernimmt keine Verantwortung oder Haftung für Schäden an Personen oder Eigentum, welche aus unsachgemäßer Anwendung von Kondensatoren herrührt.

Elektrisch oder mechanisch fehlerhaft eingesetzte Kondensatoren können explodieren oder Feuer fangen. Austretende Materialien bzw. Metallteile können gesundheitliche und materielle Schäden verursachen.

Bitte beachten Sie die detaillierten Anweisungen in unserer Broschüre „Anwendungshinweise“ sowie auf der Webseite von ELECTRONICON: [www.electronicon.com/an](http://www.electronicon.com/an)

Bitte konsultieren Sie das Fachpersonal oder unsere Distributoren zu Fragen bezüglich Anschluss, Verwendung oder Entladung von Kondensatoren.

### Montage und Kühlung

Die Lebensdauer eines Kondensators kann durch übermäßige Wärmeeinwirkung erheblich verringert werden. Im allgemeinen führt eine Erhöhung der Umgebungstemperatur um 7°C zu einer Verringerung der Lebensdauer des Kondensators um 50 %. Halten Sie die zugelassenen Betriebstemperaturen ein.

Um Überhitzung zu vermeiden, muß gewährleistet sein, daß die Kondensatoren auftretende Verlustwärme ungehindert abführen können und vor fremden Wärmequellen abgeschirmt werden. Insbesondere in Filtern ist in jedem Falle eine Zwangslüftung zu empfehlen. Zwischen und um Kondensatoren sollten etwa 20 mm Platz für natürliche oder Zwangslüftung belassen werden. Bringen Sie den Kondensator nie direkt neben oder über Wärmequellen, wie Drosseln u. ä. an.





### Failure Rate

The failure probability of a component is a statistical value which is described by a log-normal distribution:

$$N = N_0 \times e^{-\lambda t}$$

$\lambda$  is the failure rate, which alternatively is also stated as the so-called FIT-rate (FIT = Failures In Time =  $\lambda \times 10^9$ ).

The failure rate is very closely linked with operating temperature and operating voltage of the capacitor. The FIT rates stated in this catalogue are related to the capacitor's rated voltage and a dielectric temperature (= HOTSPOT temperature) of 70°C.

The simultaneous operation of capacitors at highest permissible voltage and operating temperature should be avoided; otherwise, failure rates may increase beyond reasonable technical reliability.

The standard reference period for the failure rate statement is 100.000 hours. Please note that FIT rates can be altered or improved by technical adjustments. Please contact us for details.

The following diagram demonstrates the correlation between FIT rate, operating voltages and operating temperatures.

### Ausfallrate

Die Ausfallwahrscheinlichkeit eines Bauelements ist eine statistische Größe, die mit Hilfe einer Normalverteilung beschrieben wird. Es gilt:

$N$  = number of functional components after period  $t$   
Anzahl der nach der Zeit  $t$  intakten Bauelemente

$N_0$  = total number of components at time  $t = 0$   
Gesamtzahl der Bauelemente zum Zeitpunkt  $t = 0$

$\lambda$  = failure rate Ausfallrate

Dabei ist  $\lambda$  die Ausfallrate, die alternativ auch als FIT-Rate angegeben wird (FIT =  $\lambda \times 10^9$ )

Die Ausfallrate ist stark abhängig von der Temperatur und der Betriebsfeldstärke. Die FIT-Raten im Katalogsortiment beziehen sich auf 70°C Dielektrikumtemperatur (=Hotspot-Temperatur) und die Nennspannung des Kondensators.

Der Betrieb von Kondensatoren mit der höchsten zulässigen Spannung und der höchsten zulässigen Betriebstemperatur sollte vermieden werden, andernfalls können die Ausfallraten so hoch werden, dass keine technisch sinnvollen Zuverlässigkeiten mehr gewährleistet sind.

Der Wert für die Ausfallrate bezieht sich auf einen Referenzzeitraum von 100.000h. FIT-Raten können durch technische Anpassung der Kondensatoren beeinflusst und verbessert werden. Auskünfte hierzu erteilen wir auf Anfrage.

Das nachstehende Kurvendiagramm macht den Zusammenhang von FIT-Rate, Betriebsspannung und Betriebstemperatur deutlich.

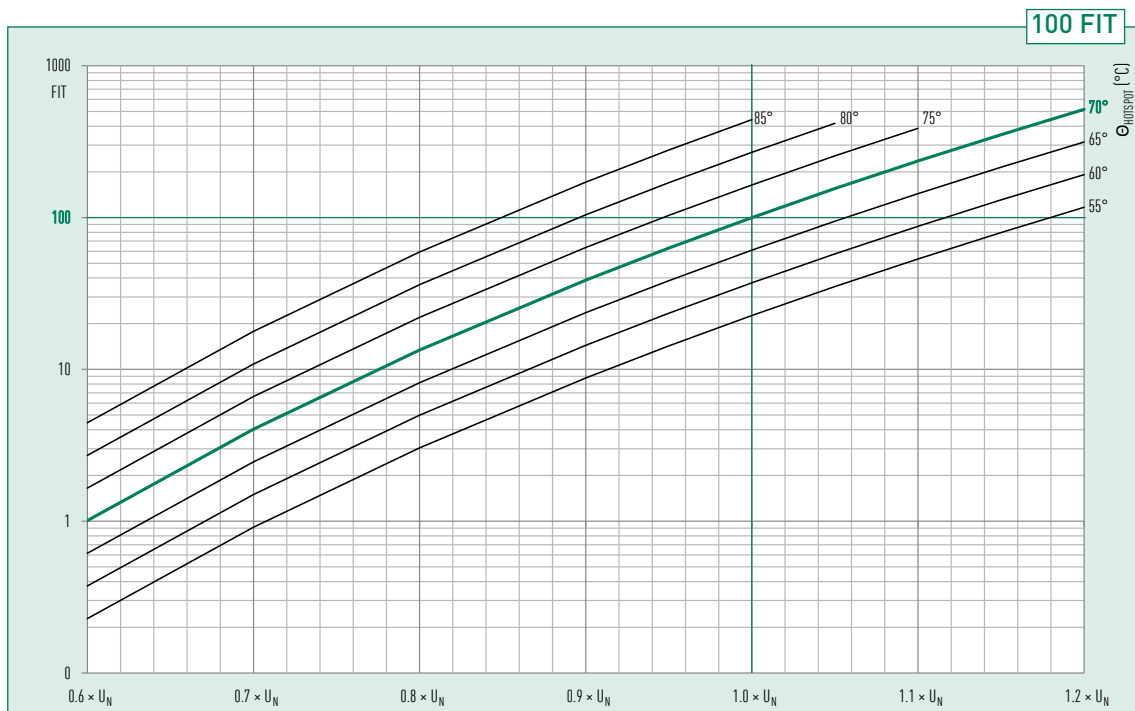

**Protection against Overvoltages And Short Circuits:  
Self-Healing Dielectric**

All dielectric structures used in our power capacitors are „selfhealing“: In the event of a voltage breakdown the metal layers around the breakdown channel are evaporated by the temperature of the electric arc that forms between the electrodes. They are removed within a few microseconds and pushed apart by the pressure generated in the centre of the breakdown spot. An insulation area is formed which is reliably resistive and voltage proof for all operating requirements of the capacitor. The capacitor remains fully functional during and after the breakdown.

For voltages within the permitted testing and operating limits the capacitors are short-circuit- and overvoltage-proof. They are also proof against external short circuits as far as the resulting surge discharges do not exceed the specified surge current limits.

**Functioning of the BAM™ (Break Action Mechanism)**

In the event of overvoltage or thermal overload or ageing at the end of the capacitor's useful service life, an increasing number of self-healing breakdowns may cause rising pressure inside the capacitor. To prevent it from bursting, the capacitor is fitted with an obligatory „break action mechanism“ (BAM™). The BAM™ is based on attenuated spots at two, or all three of the connecting wires inside the capacitor.

All capacitors with diameters < 85 mm as well as some traditional models with large diameters are provided with BAM 1 mechanism. All new models with diameters ≥ 85 mm will be provided with BAM 2 mechanism. With rising pressure the case begins to expand, mainly by opening the folded crimp and pushing the lid upwards. As a result, the prepared connecting wires are separated at the attenuated spot, and the current path is interrupted irreversibly.

**Schutz gegen Überspannungen und Kurzschlüsse:  
Selbstheilendes Dielektrikum**

Alle in unseren Leistungskondensatoren eingesetzten dielektrischen Strukturen sind selbstheilend. Im Falle eines Kurzschlusses (Spannungsdurchschlag) verdampfen die Metallbeläge um den Durchschlagpunkt herum infolge des Lichtbogens, der sich zwischen den Elektroden bildet. Binnen Mikrosekunden wird der Metaldampf vom Zentrum des Durchschlages weggedrückt. Auf diese Weise bildet sich eine isolierende belagfreie Zone um den Durchschlagpunkt. Der Kondensator bleibt während und nach dem Durchschlag voll funktionsfähig.

Für Spannungen innerhalb der zugelassenen Test- und Betriebsbedingungen sind die Kondensatoren kurzschluss- und überspannungssicher. Sie sind außerdem sicher gegen äußere Kurzschlüsse, sofern bei den dabei entstehenden Stoßentladungen die zugelassenen Stoßströme nicht überschritten werden.

**Funktion der Abreißsicherung (BAM™)**

Bei spannungsmäßiger oder thermischer Überlastung bzw. am Ende der Lebensdauer kann durch zahlreiche Selbstheildurchschläge ein Überdruck im Kondensator entstehen. Um ein Bersten der Gehäuse zu verhindern, sind die Kondensatoren generell mit einer Überdruck-Abreißsicherung (BAM™) versehen. Diese Sicherung besteht aus einer Sollbruchstelle in zwei oder allen Anschlussdrähten.

Alle Kondensatoren mit Durchmesser < 75 mm sowie einige traditionelle Modelle mit größeren Durchmessern sind mit der BAM 1 Sicherung versehen. Alle neuen Modelle mit Durchmesser ≥ 85 mm werden mit BAM 2 Sicherung ausgestattet. Bei einem Überdruck im Kondensator verlängert sich das Gehäuse durch das Öffnen der gestauchten Sicke bzw. Wölbung des Metalldeckels und die Stromzufuhr zu den Kondensatorwickeln wird an den Sollbruchstellen irreversibel unterbrochen.

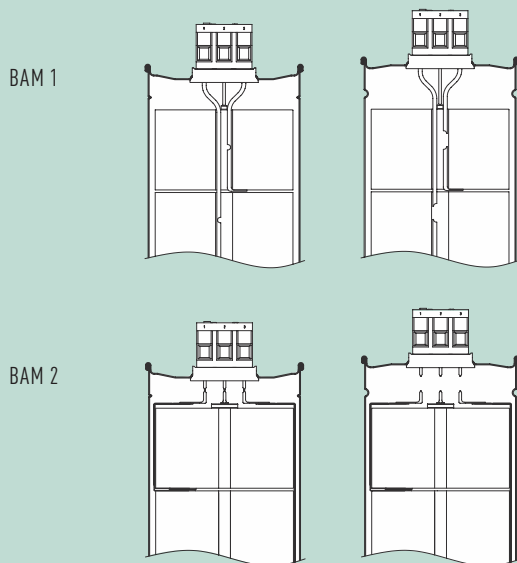

### Limited Warranty

All our products are designed, manufactured, and tested with the highest care and workmanship. The satisfaction of our customers is our highest goal. We therefore warrant remedying any defect in the goods resulting from faulty design, materials or workmanship, which appears within 3 years from the date of sale.

This warranty does not cover defects due to improper use of the goods or operation at conditions exceeding the rated values stated in the catalogue or special data sheet. Nor does it cover defects due to faulty maintenance or incorrect installation, alterations or faulty repairs undertaken by the Buyer. Finally the warranty does not cover normal wear and tear or deterioration.

See our „General Conditions“ for details on Warranty and Product liability.

### Gewährleistung

Alle unsere Erzeugnisse werden mit höchster Sorgfalt und Fachkenntnis entwickelt, hergestellt und geprüft. Die Zufriedenheit unserer Kunden ist unser höchstes Ziel. Wir verpflichten uns daher, jeden innerhalb von 3 Jahren ab Verkaufsdatum auftretenden Mangel an unseren Erzeugnissen zu beseitigen, welcher aus Fehlern in Design, Material oder Herstellung herrührt.

Diese Gewährleistung erstreckt sich nicht auf Defekte infolge unsachgemäßer Anwendung oder Betrieb außerhalb der nach Katalog oder Datenblatt zulässigen Einsatzbedingungen. Sie erfaßt ebensowenig Schäden aufgrund fehlerhafter Wartung, unsachgemäßer Montage, Änderungen oder unsachgemäßer Reparaturen durch den Käufer bzw. Anwender. Diese Gewährleistung betrifft auch nicht normale Abnutzung und Verschleiß.

Siehe unsere „Allgemeinen Geschäftsbedingungen“ für Details zu Gewährleistung und Produkthaftung.

Find more information and detailed instructions in our „Application Notes“ and on [www.electronicon.com](http://www.electronicon.com)  
Mehr Informationen und ausführliche Anweisungen finden Sie in unseren „Anwendungshinweisen“ und unter [www.electronicon.com](http://www.electronicon.com)

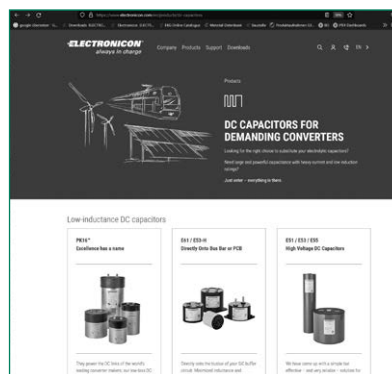
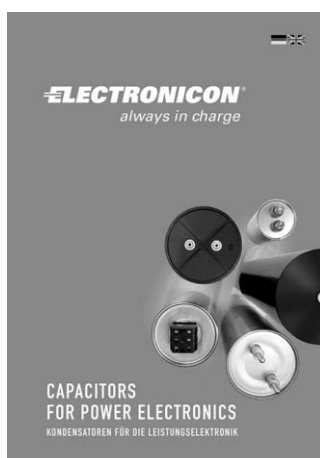

NOTES  
NOTIZEN

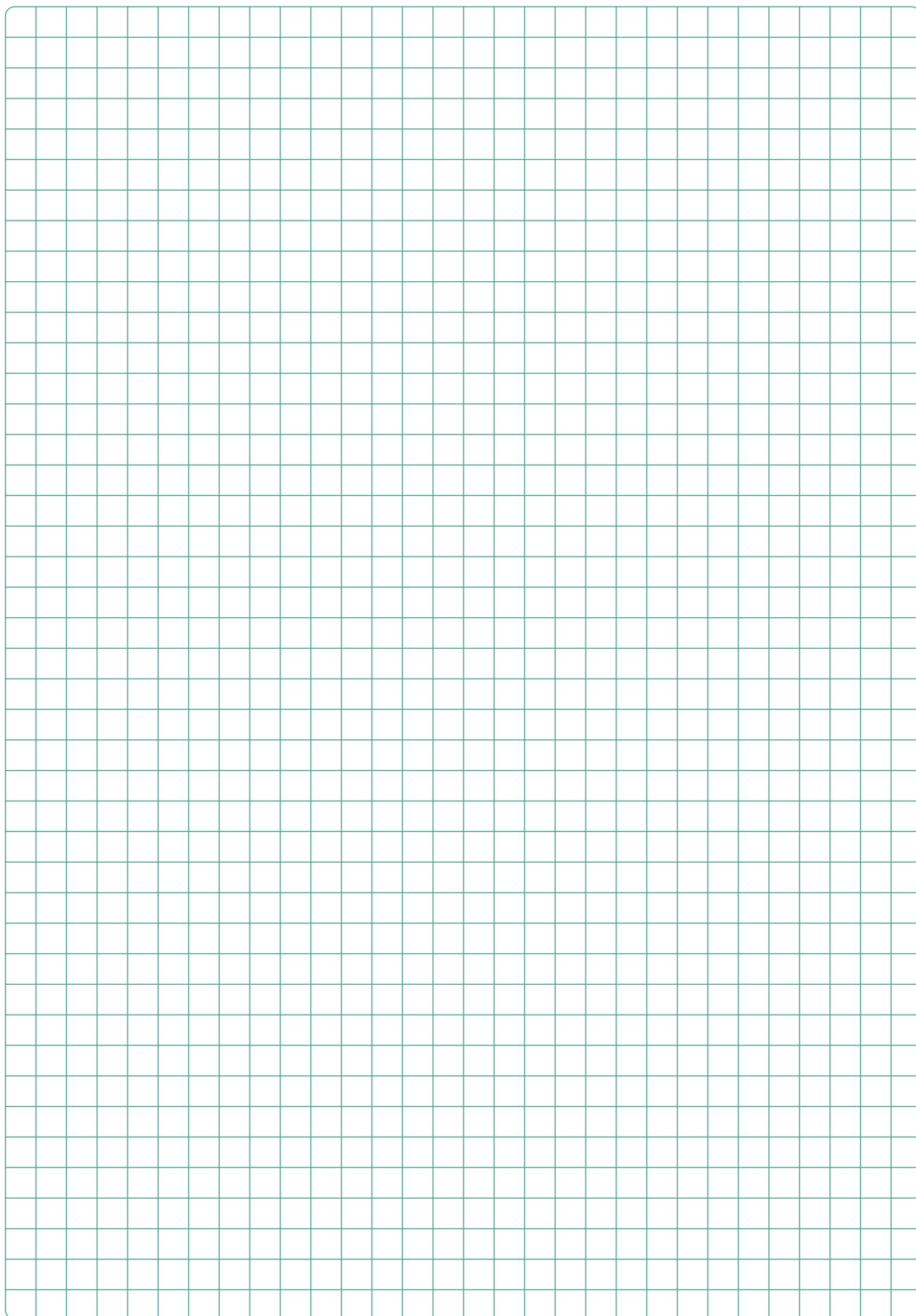

NOTES\_NOTIZEN



# APPLICATION NOTES AND GENERAL INFORMATION



**ELECTRONICON**<sup>®</sup>  
always in charge



**CAPACITORS  
FOR POWER ELECTRONICS**  
KONDENSATOREN FÜR DIE LEISTUNGSELEKTRONIK

des  $I_{max}$  und  $f$ .  
dem errechneten



## EXCELLENT EXPERIENCE IN CAPACITOR MAKING FOR OVER 80 YEARS

Gera has been a centre of capacitor making since 1938. ELECTRONICON Kondensatoren GmbH which emerged from previous RFT/VEB ELEKTRONIK Gera in 1992, has become one of Europe's leading capacitor manufacturers supplying customers worldwide and being an open and competent partner for manufacturers and users of power factor correction equipment, for many manufacturers of drives, power electronics, home appliances, and for the lighting industry. Regular investments in advanced and environmentally sound technologies guarantee the highest levels in manufacture and quality to modern standards which are approved and monitored by leading certification authorities.

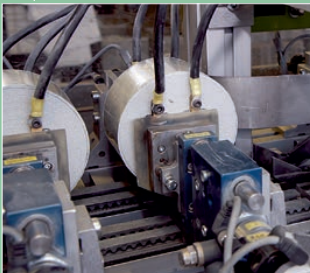

In today's globalised competition, we distinguish ourselves by

- Absolute reliability and safety of our products
- Close co-operation between manufacturer and client to meet both technical and commercial requirements
- Improvement and development of our technical expertise in capacitor design and manufacture, as well as film coating, with special attention paid to the MKPg-technology
- Early identification and incorporation of new trends and methods in the manufacturing of capacitors
- Flexibility and punctual fulfilment of our commercial obligations

Our experienced development engineers are competent and responsible for both implementing the latest technical trends applicable to our products and ensuring that our products adapt to the challenges of traditional and new markets.

The close and intense co-operation between the departments of Marketing & Sales, Research & Development, and Production has become the keystone of our success. ELECTRONICON is continually striving to establish a similarly close and interactive relationship with its distributors and direct clients both in home and overseas markets, to become not just one out of many suppliers, but your preferred partner for ideas and solutions.

# ELECTRONICON®

Germany • 07549 Gera • Keplerstrasse 2  
Fon +49 365 / 734 61 00 • Fax +49 365 / 734 61 10  
E-Mail: [sales@electronicon.com](mailto:sales@electronicon.com), [www.electronicon.com](http://www.electronicon.com)

