

DST860S-A

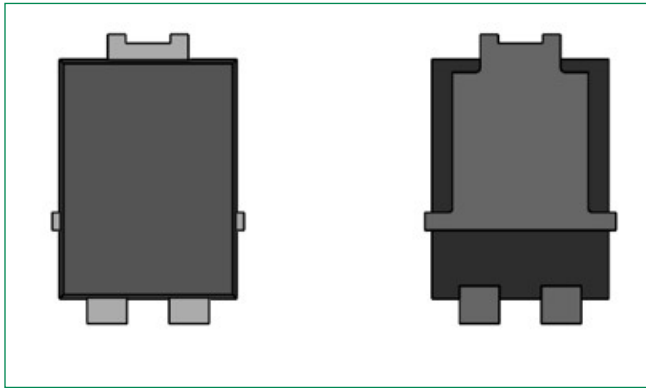

Pin out

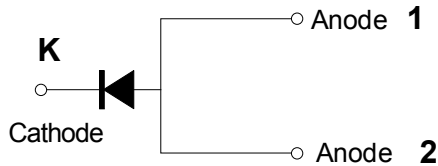

Description

Littelfuse DST series Ultra Low V_F Schottky Barrier Rectifier is designed to meet the general requirements of automotive applications by providing high temperature, low leakage and lower V_F products.

It is suitable for high frequency switching mode power supply, free-wheeling diodes and polarity protection diodes.

Features

- High reliability application and AEC-Q101 qualified
- Ultra low forward voltage drop
- High frequency operation
- MSL: Level 1 - unlimited
- High junction temperature capability
- Trench MOS Schottky technology
- Single die in TO-277B Package
- Pb-free E3 means 2nd level interconnect is Pb-free and the terminal finish material is tin(Sn) (IPC/ JEDEC J-STD-609A.01)

Applications

- Switching mode power supply
- DC/DC converters
- Free-Wheeling diodes
- Polarity Protection Diodes

Maximum Ratings

Parameters	Symbol	Test Conditions	Max	Unit
Peak Inverse Voltage	V_{RWM}	-	60	V
Average Forward Current	$I_{F(AV)}$	50% duty cycle @ $T_J = 125^\circ\text{C}$ rectangular wave form	8	A
Peak One Cycle Non-Repetitive Surge Current	I_{FSM}	8.3 ms, half Sine pulse	140	A

Electrical Characteristics

Parameters	Symbol	Test Conditions	Typ	Max	Unit
Forward Voltage Drop*	V_{F1}	@4A, Pulse, $T_J = 25^\circ\text{C}$	0.42	-	V
		@8A, Pulse, $T_J = 25^\circ\text{C}$	0.50	0.61	
	V_{F2}	@4A, Pulse, $T_J = 125^\circ\text{C}$	0.34	-	
		@8A, Pulse, $T_J = 125^\circ\text{C}$	0.44	0.55	
Reverse Current*	I_{R1}	@ $V_R = \text{rated } V_R, T_J = 25^\circ\text{C}$	0.02	0.6	mA
	I_{R2}	@ $V_R = \text{rated } V_R, T_J = 125^\circ\text{C}$	10	25	
Junction Capacitance	C_T	@ $V_R = 5V, T_C = 25^\circ\text{C}, f_{SIG} = 1\text{MHz}$	502	-	pF

* Pulse Width < 300 μs , Duty Cycle < 2%

Thermal-Mechanical Specifications

Parameters	Symbol	Test Conditions	Max	Unit
Junction Temperature	T_J		-55 to +150	°C
Storage Temperature	T_{stg}		-55 to +150	°C
Maximum Thermal Resistance Junction to Ambient	R_{thJA}	DC operation	75	°C/W
Maximum Thermal Resistance Junction to Lead	R_{thJL}		4	°C/W
Approximate Weight	wt		0.08	g
Case Style		TO-277B		

Figure 1: Typical Forward Characteristics

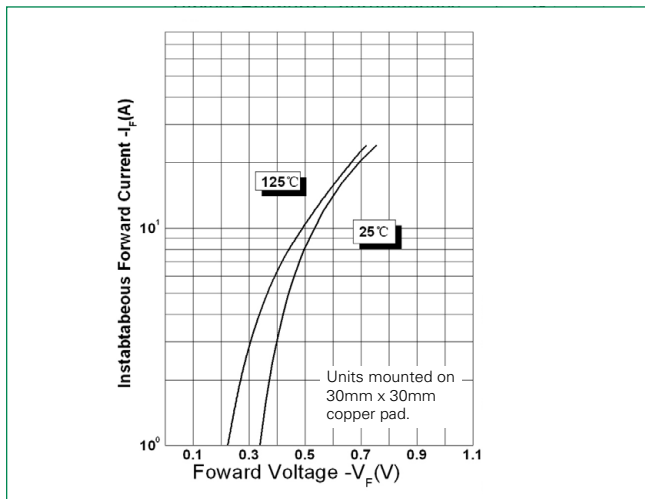

Figure 2: Typical Reverse Characteristics

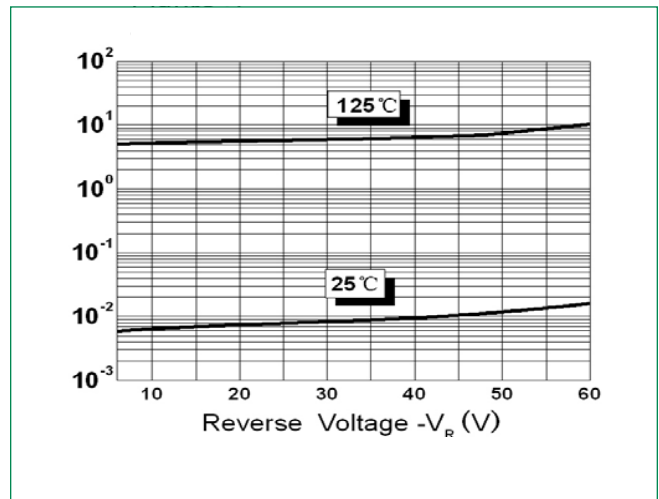
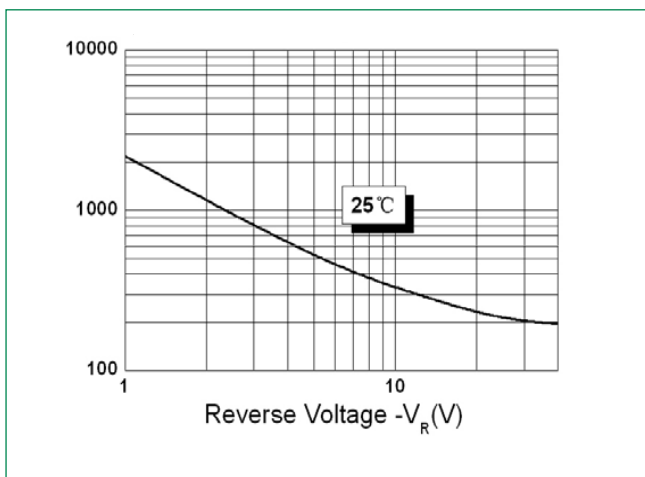
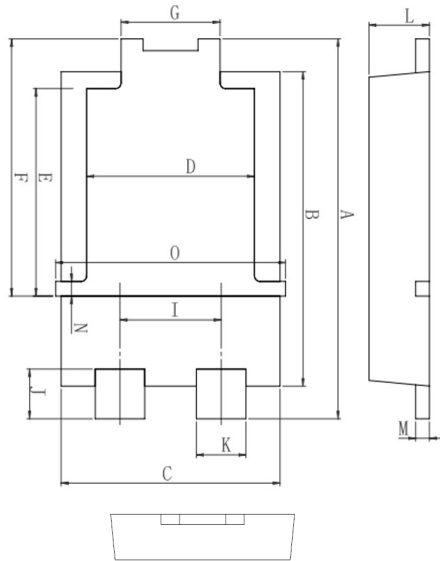

Figure 3: Typical Junction Capacitance



Dimensions-TO-277B



Symbol	Millimeters		
	Min	Typ	Max
A	6.30	6.50	6.70
B	5.28	5.38	5.48
C	3.88	3.98	4.08
D	2.90	3.05	3.20
E	3.40	3.55	3.70
F	4.20	4.40	4.60
G	1.70	1.80	1.90
I	1.74	1.84	1.94
J	0.65	0.85	1.05
K	0.85	0.90	0.95
L	0.95	1.10	1.25
M	0.20	0.25	0.30
N	0.25	0.40	0.55
O	4.00	4.05	4.25

Mounting Pad Layout

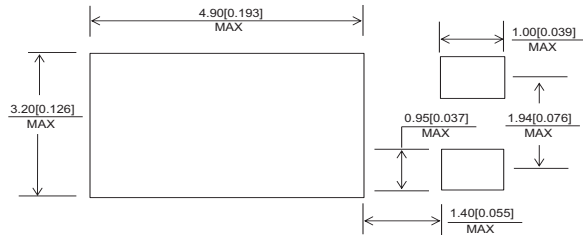

Part Numbering and Marking System

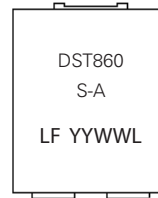

- DST = Device Type
- 8 = Forward Current (8A)
- 60 = Reverse Voltage (60V)
- S = Package Type
- A = AEC-Q101 qualified device
- LF = Littelfuse
- YY = Year
- WW = Week
- L = Lot Number

Packing Options

Part Number	Marking	Packing Mode	M.O.Q
DST860S-A	DST860S-A	5000pcs / Reel	5000

Carrier Tape & Reel Specification

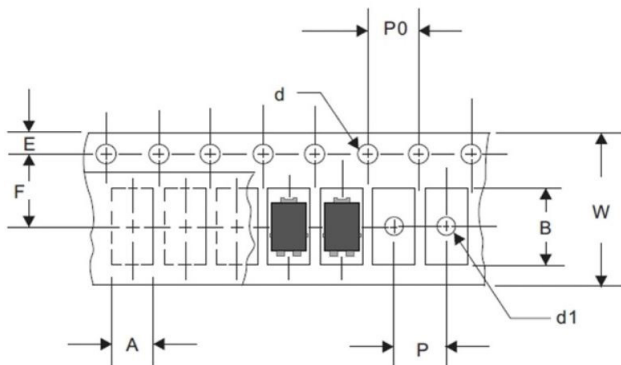

Symbol	Millimeters	
	Min	Max
A	4.28	4.48
B	6.80	7.00
d	1.40	1.60
d1	-	1.50
E	1.65	1.85
F	5.40	5.60
P	7.90	8.10
P0	3.90	4.10
W	11.70	12.30