

**High Voltage
BIMOSFET™ Monolithic
Bipolar MOS Transistor
Extended FBSOA**

**IXCH36N250
IXCK36N250**

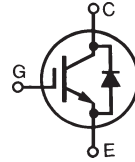

$$V_{CES} = 2500V$$

$$I_{C110} = 36A$$

$$V_{CE(sat)} \leq 3.3V$$

Symbol	Test Conditions	Maximum Ratings	
V_{CES}	$T_C = 25^\circ C$ to $150^\circ C$	2500	V
V_{CGR}	$T_J = 25^\circ C$ to $150^\circ C$, $R_{GE} = 1M\Omega$	2500	V
V_{GES}	Continuous	± 25	V
V_{GEM}	Transient	± 35	V
I_{C25}	$T_C = 25^\circ C$	73	A
I_{C110}	$T_C = 110^\circ C$	36	A
I_{CM}	$T_C = 25^\circ C$, 1ms	360	A
SSOA (RBSOA)	$V_{GE} = 15V$, $T_{VJ} = 125^\circ C$, $R_G = 20\Omega$ Clamped Inductive Load	$I_{CM} = 144$ $V_{CE} \leq 0.8 \cdot V_{CES}$	A
T_{SC} (SCSOA)	$V_{GE} = 15V$, $T_J = 125^\circ C$, $R_G = 82\Omega$, $V_{CE} = 1250V$, Non-Repetitive	10	μs
P_C	$T_C = 25^\circ C$	595	W
T_J		-55 ... +150	$^\circ C$
T_{JM}		150	$^\circ C$
T_{stg}		-55 ... +150	$^\circ C$
T_L	1.6mm (0.062 in.) from Case for 10s	300	$^\circ C$
T_{SOLD}	Plastic Body for 10 seconds	260	$^\circ C$
M_d	Mounting Torque	1.13/10	Nm/lb.in.
Weight	TO-247	6	g
	TO-264	10	g

TO-247 AD

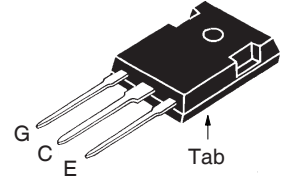

TO-264

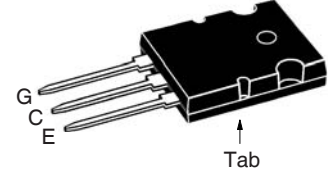

G = Gate E = Emitter
C = Collector Tab = Collector

Features

- High Blocking Voltage
- High Peak Current Capability
- Anti-Parallel Diode
- Low Saturation Voltage
- Extended FBSOA and SCSOA

Advantages

- Low Gate Drive Requirement
- High Power Density

Applications

- Switch-Mode and Resonant-Mode Power Supplies
- Uninterruptible Power Supplies (UPS)
- Laser Generators
- Capacitor Discharge Circuits
- AC Switches
- Protection Circuits

Symbol	Test Conditions ($T_J = 25^\circ C$, Unless Otherwise Specified)	Characteristic Values		
		Min.	Typ.	Max.
BV_{CES}	$I_C = 250\mu A$, $V_{GE} = 0V$	2500		V
$V_{GE(th)}$	$I_C = 250\mu A$, $V_{CE} = V_{GE}$	4.0		6.5 V
I_{CES}	$V_{CE} = V_{CES}$, $V_{GE} = 0V$ $T_J = 125^\circ C$			50 μA 1.75 mA
I_{GES}	$V_{CE} = 0V$, $V_{GE} = \pm 25V$			± 100 nA
$V_{CE(sat)}$	$I_C = 36A$, $V_{GE} = 15V$, Note 1 $T_J = 125^\circ C$	2.6		3.3 V
		3.0		V

Symbol Test Conditions ($T_J = 25^\circ\text{C}$ Unless Otherwise Specified)		Characteristic Values		
		Min.	Typ.	Max.
g_{fs}	$I_C = 36\text{A}, V_{CE} = 10\text{V}, \text{Note 1}$	22	33	S
C_{ies}	$V_{CE} = 25\text{V}, V_{GE} = 0\text{V}, f = 1\text{MHz}$	3980		pF
C_{oes}		170		pF
C_{res}		60		pF
Q_g	$I_C = 36\text{A}, V_{GE} = 15\text{V}, V_{CE} = 1000\text{V}$	177		nC
Q_{ge}		30		nC
Q_{gc}		80		nC
$t_{d(on)}$	Resistive Switching Times, $T_J = 25^\circ\text{C}$ $I_C = 36\text{A}, V_{GE} = 15\text{V}$ $V_{CE} = 1250\text{V}, R_G = 20\Omega$	115		ns
t_r		580		ns
$t_{d(off)}$		430		ns
t_f		880		ns
$t_{d(on)}$	Resistive Switching Times, $T_J = 125^\circ\text{C}$ $I_C = 36\text{A}, V_{GE} = 15\text{V}$ $V_{CE} = 1250\text{V}, R_G = 20\Omega$	105		ns
t_r		830		ns
$t_{d(off)}$		480		ns
t_f		900		ns
R_{thJC}				0.21 $^\circ\text{C/W}$
R_{thCS}	TO-247	0.21		$^\circ\text{C/W}$
	TO-264	0.15		$^\circ\text{C/W}$

Reverse Diode

Symbol Test Conditions ($T_J = 25^\circ\text{C}$ Unless Otherwise Specified)		Characteristic Values		
		Min.	Typ.	Max
V_F	$I_F = 36\text{A}, V_{GE} = 0\text{V}, \text{Note 1}$			2.5 V
t_{rr}	$I_F = 23\text{A}, V_{GE} = 0\text{V}, -di_F/dt = 100\text{A}/\mu\text{s}$	1.7		μs
I_{RM}		43		A

Note:

1. Pulse test, $t \leq 300\mu\text{s}$, duty cycle, $d \leq 2\%$.

Additional provisions for lead to lead voltage isolation are required at $V_{CE} > 1200\text{V}$.

IXYS Reserves the Right to Change Limits, Test Conditions and Dimensions.

IXYS MOSFETs and IGBTs are covered by one or more of the following U.S. patents:	4,835,592	4,931,844	5,049,961	5,237,481	6,162,665	6,404,065 B1	6,683,344	6,727,585	7,005,734 B2	7,157,338B2
	4,850,072	5,017,508	5,063,307	5,381,025	6,259,123 B1	6,534,343	6,710,405 B2	6,759,692	7,063,975 B2	
	4,881,106	5,034,796	5,187,117	5,486,715	6,306,728 B1	6,583,505	6,710,463	6,771,478 B2	7,071,537	

TO-247 (IXCH) Outline

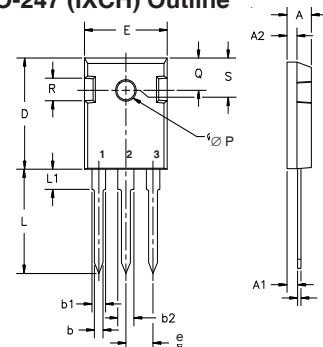

Terminals: 1 - Gate 2 - Collector
3 - Emitter

Dim.	Millimeter		Inches	
	Min.	Max.	Min.	Max.
A	4.7	5.3	.185	.209
A ₁	2.2	2.54	.087	.102
A ₂	2.2	2.6	.059	.098
b	1.0	1.4	.040	.055
b ₁	1.65	2.13	.065	.084
b ₂	2.87	3.12	.113	.123
C	.4	.8	.016	.031
D	20.80	21.46	.819	.845
E	15.75	16.26	.610	.640
e	5.20	5.72	0.205	0.225
L	19.81	20.32	.780	.800
L1		4.50		.177
∅P	3.55	3.65	.140	.144
Q	5.89	6.40	0.232	0.252
R	4.32	5.49	.170	.216
S	6.15	BSC	242	BSC

TO-264 (IXCK) Outline

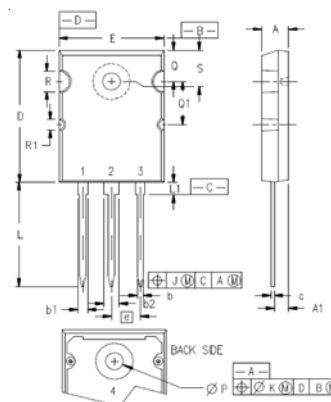

Terminals: 1 = Gate
2,4 = Collector
3 = Emitter

SYM	INCHES		MILLIMETERS	
	MIN	MAX	MIN	MAX
A	.185	.209	4.70	5.31
A1	.102	.118	2.59	3.00
b1	.037	.055	0.94	1.40
b2	.110	.126	2.79	3.20
c	.017	.029	0.43	0.74
D	1.007	1.047	25.58	26.59
E	.760	.799	19.30	20.29
e	.215BSC		5.46 BSC	
J	.000	.010	0.00	0.25
K	.000	.010	0.00	0.25
L	.779	.842	19.79	21.39
L1	.087	.102	2.21	2.59
∅P	.122	.136	3.10	3.51
Q	.240	.256	6.10	6.50
Q1	.330	.346	8.38	8.79
∅R	.155	.187	3.94	4.75
∅R1	.085	.093	2.16	2.36
S	.243	.253	6.17	6.43

Fig. 1. Output Characteristics @ $T_J = 25^\circ\text{C}$

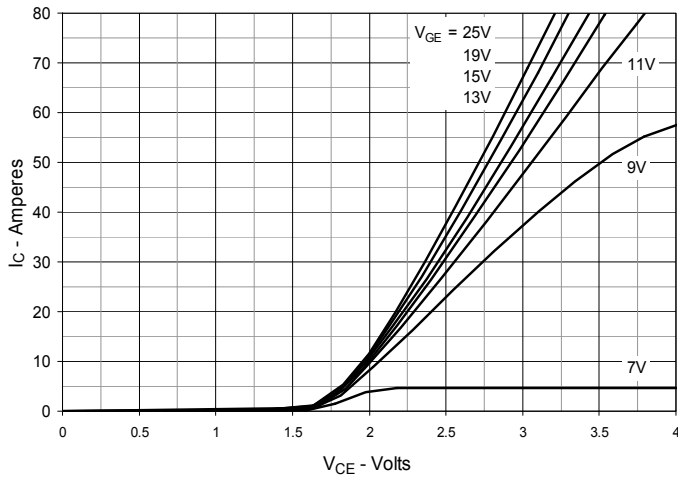

Fig. 2. Extended Output Characteristics @ $T_J = 25^\circ\text{C}$

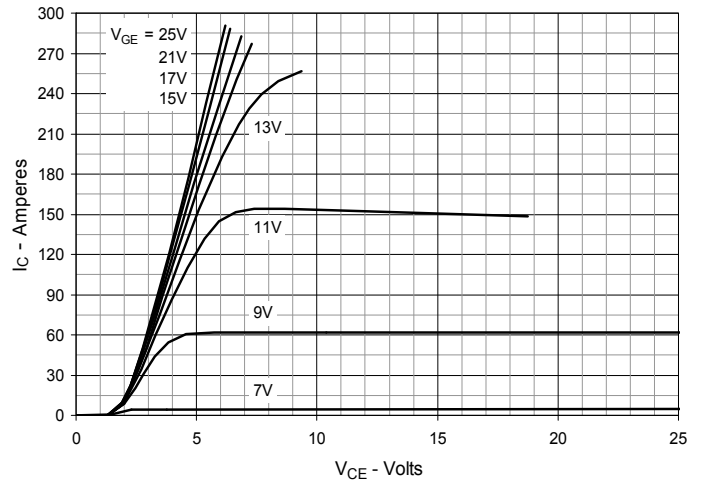

Fig. 3. Output Characteristics @ $T_J = 125^\circ\text{C}$

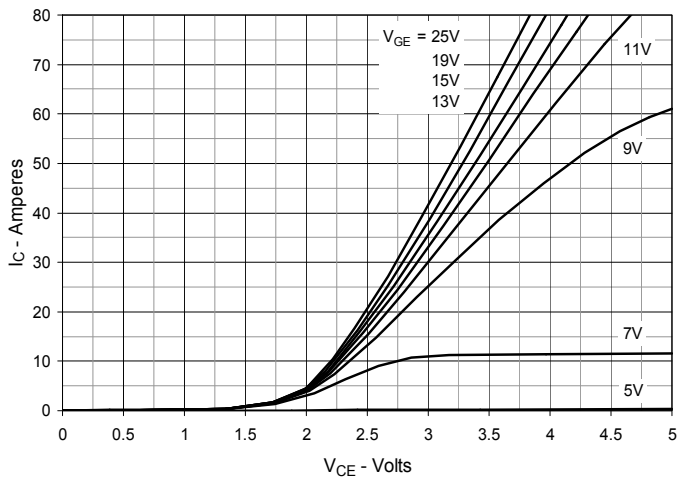

Fig. 4. Dependence of $V_{CE(sat)}$ on Junction Temperature

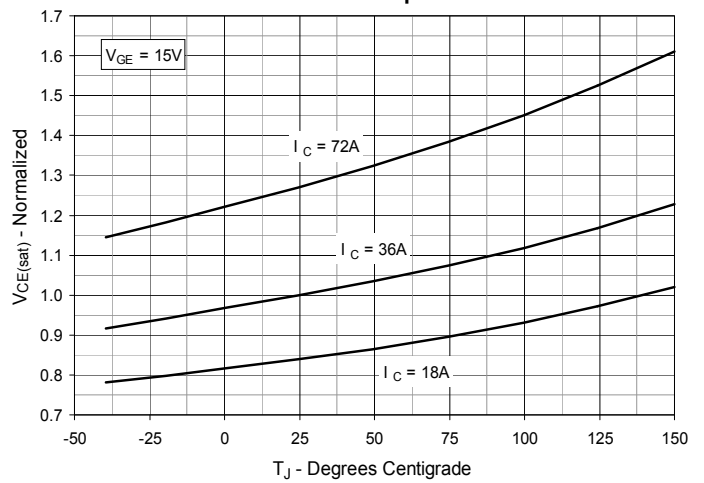

Fig. 5. Collector-to-Emitter Voltage vs. Gate-to-Emitter Voltage

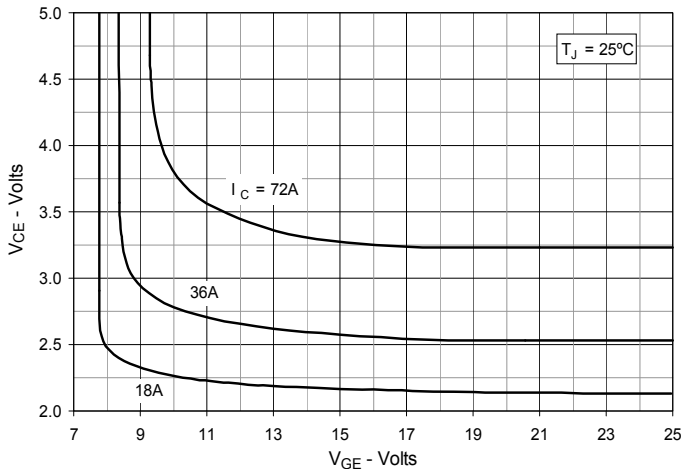

Fig. 6. Input Admittance

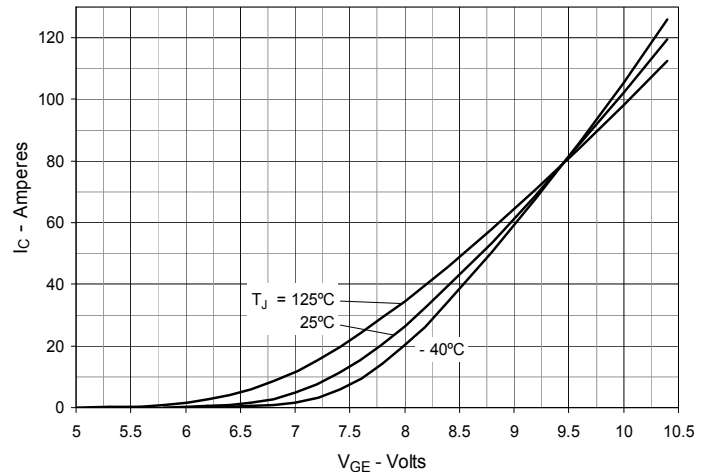

Fig. 7. Transconductance

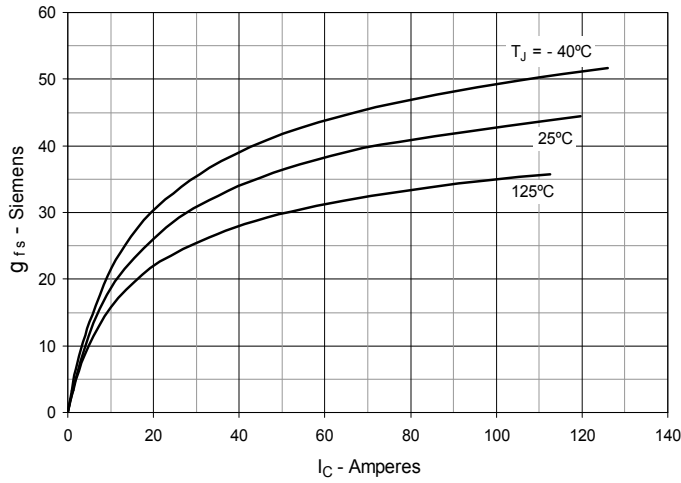

Fig. 8. Forward Voltage Drop of Intrinsic Diode

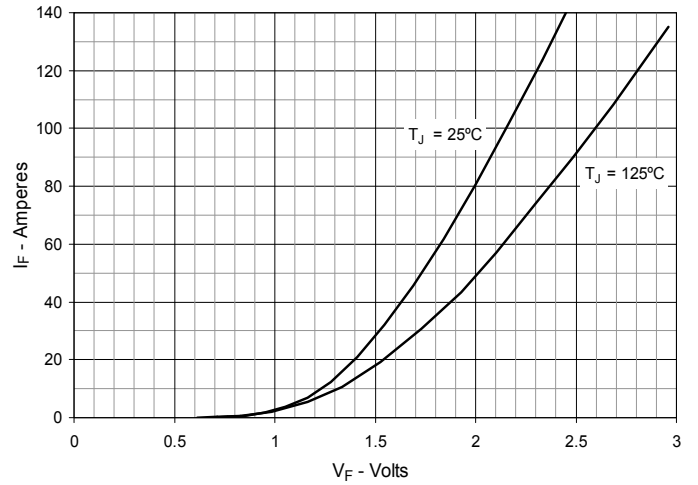

Fig. 9. Gate Charge

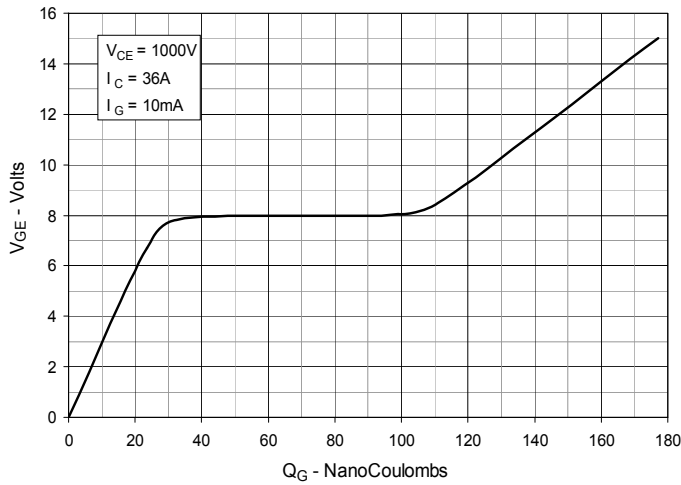

Fig. 10. Capacitance

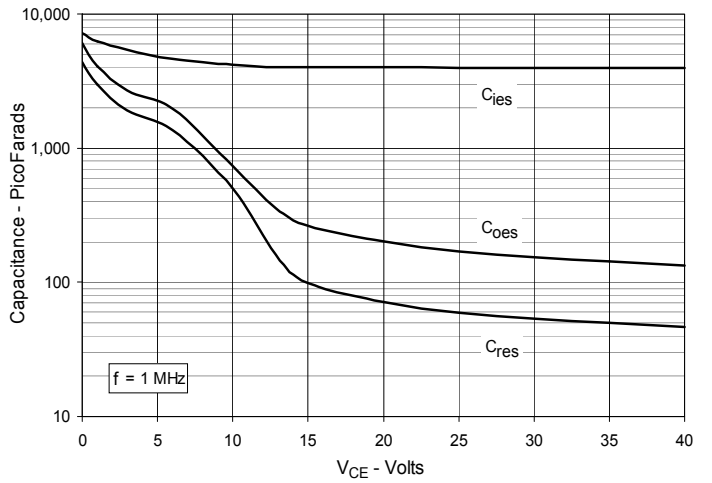

Fig. 11. Reverse-Bias Safe Operating Area

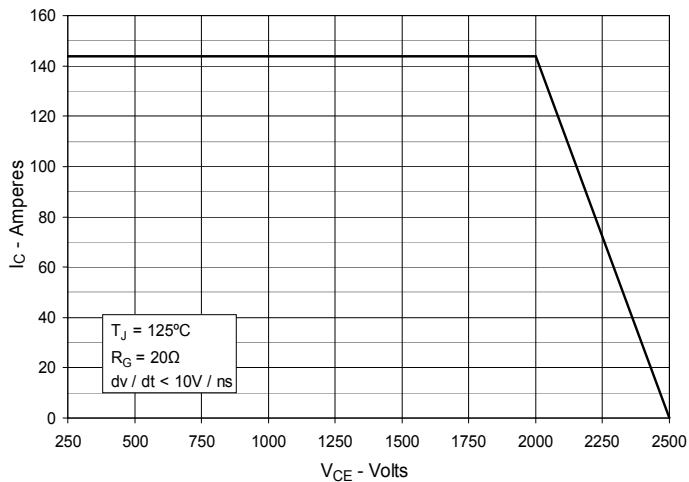

Fig. 12. Maximum Transient Thermal Impedance

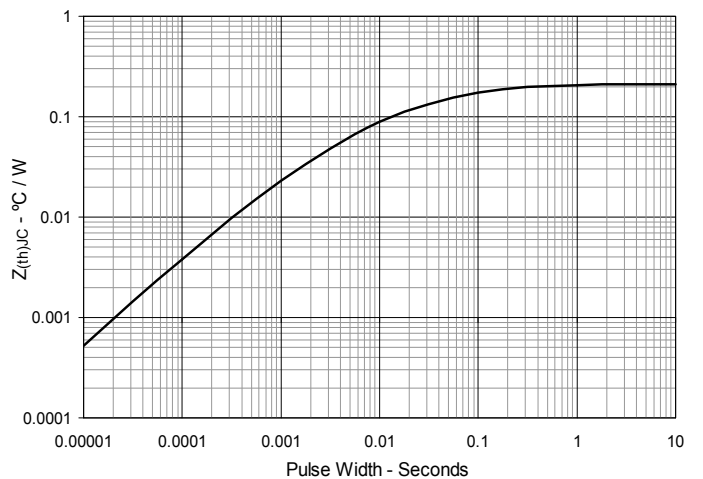

Fig. 13. Forward-Bias Safe Operating Area @ $T_C = 25^\circ\text{C}$

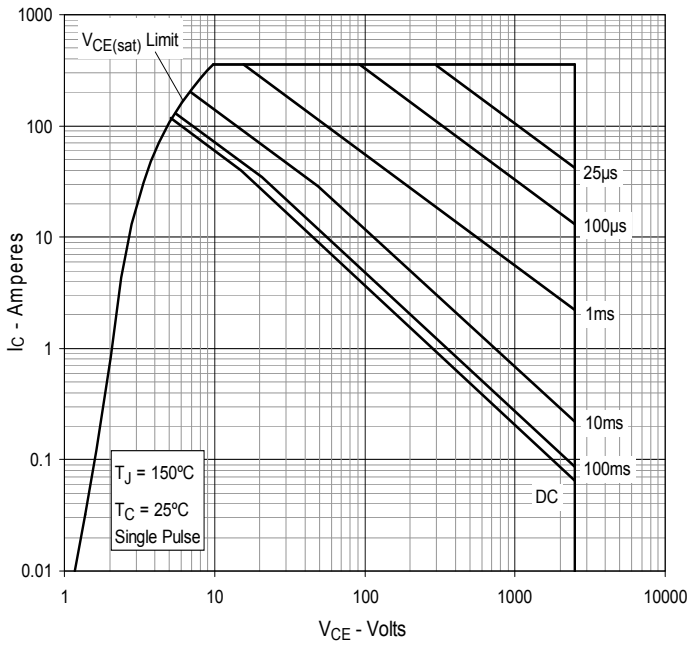
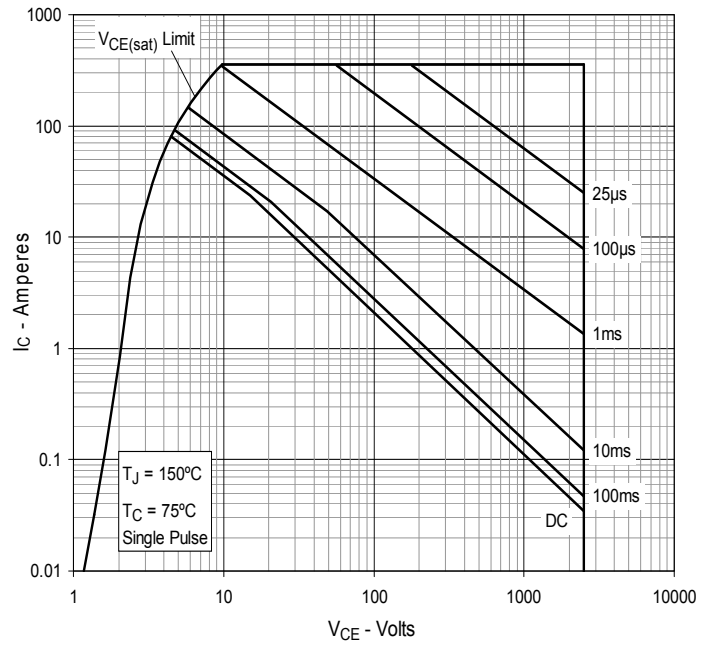

Fig. 14. Forward-Bias Safe Operating Area @ $T_C = 75^\circ\text{C}$





Disclaimer Notice - Information furnished is believed to be accurate and reliable. However, users should independently evaluate the suitability of and test each product selected for their own applications. Littelfuse products are not designed for, and may not be used in, all applications. Read complete Disclaimer Notice at www.littelfuse.com/disclaimer-electronics.

Forward-Biased, Reverse-Biased, and Short-Circuit Safe Operating Area of MOSFETs and IGBTs



Objectives

This document explains the operating conditions that a power semiconductor is supposed to work in without being damaged. Focus is set on the *Forward-Biased Safe Operating Area (FBSOA)*, the *Reverse Biased, Safe Operating Area (RBSOA)* and the *Short-Circuit Safe Operating Area (SCSOA)*.

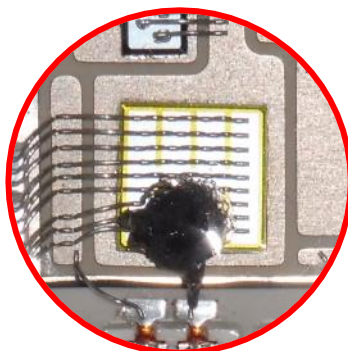

Figure 1. To be prevented – an IGBT destroyed by RBSOA-exceedance

Applications

The information compiled in this document is relevant for the power semiconductor itself and thus for all its applications.

Target Audience

This document is intended for all developers, design- and test-engineers involved in building power semiconductor applications.

Contact Information

For more information on the topic of safely operating power devices, contact the Littelfuse Power Semiconductor team of product and applications experts:

- PowerSemiSupport@Littelfuse.com

Table of Contents

1. Safe Operating Area (SOA), also called Forward-Bias Safe Operating Area (FBSOA).....	4
2. Reverse Biased Safe Operating Area (RBSOA)	5
3. Short-Circuit Safe Operating Area (SCSOA).....	6
4. Resulting challenges for the designer	6
5. Conclusion.....	8

List of Figures

Figure 1. To be prevented – an IGBT destroyed by RBSOA-exceedance	1
Figure 2. SOA Diagram for the IXTX46N50L	4
Figure 3. Voltage and current waveforms during a turn-off event	5
Figure 4. RBSOA-shape, limited by maximum current and breakdown voltage	5
Figure 5. SCSOA information taken from the MDMA280UB1600PTED datasheet.....	6
Figure 6. RBSOA, SCSOA, and the undefined region in between.....	6
Figure 7. Measurement results from a destructive turn-off event.....	7
Figure 8. Locating the point of turn-off	7
Figure 9. Properly turned off overcurrent or short-circuit event.....	8

Introduction

Power semiconductors like IGBTs, GTOs, thyristors, diodes, or bipolar junction transistors (BJT) have been developed into robust and reliable devices which can by now handle power levels into the MW-range and even beyond.

Despite these developments, they all have physical limitations which need to be known and respected to prevent damage to these components and the system they are mounted in. Depending on the instantaneous mode of operation, different conditions are described by a varying set of parameters, often referred to as operating area.

1. Safe Operating Area (SOA), also called Forward-Bias Safe Operating Area (FBSOA)

When a power semiconductor like an IGBT is used to conduct current in the predestined direction, the physical limits of the device to be considered include:

- the maximum collector current I_C ,
- the saturation voltage V_{CEsat} across the device,
- the power generated by the product $I_C \cdot V_{CEsat}$, and
- the maximum junction temperature T_{VJ} allowed.

In cases where the power semiconductor is a MOSFET, dedicated to be operated in linear mode, the current can be influenced by tuning the gate-source-voltage accordingly. As a consequence, the drain-source-voltage V_{DS} of the devices changes which in turn impacts the losses. The device must dissipate these losses and the thermal impedance of the device poses the limits here.

For these operating conditions, the FBSOA-diagram features the forward voltage, the current and limits imposed by thermal development. Looking at Figure 2, it becomes obvious that growing losses can only be tolerated for shorter periods of time.

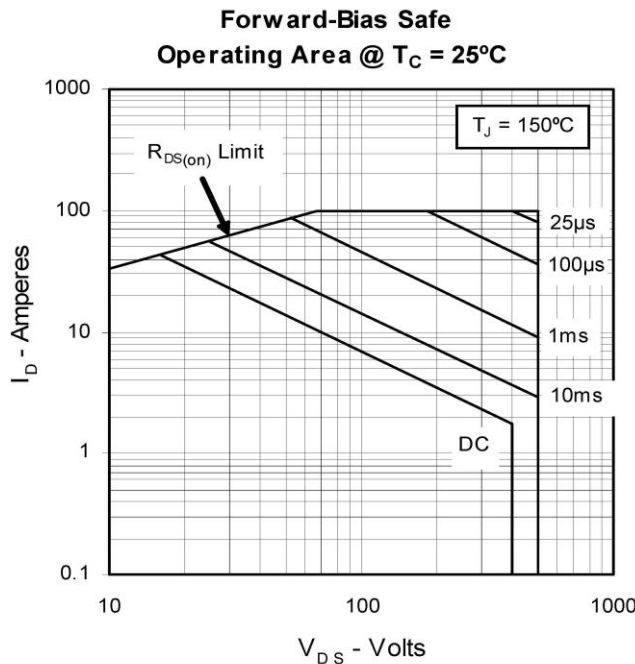

Figure 2. SOA Diagram for the IXTX46N50L

Any combination of forward voltage and current that is found below the correlating lines within the diagram is a legal point of operation as long as the junction temperature remains below the maximum limit and the duration of the loading is properly chosen. De-rating must be considered if the case temperature is different from the 25°C the diagram in Figure 2 refers to.

2. Reverse Biased Safe Operating Area (RBSOA)

Power semiconductors like IGBTs or MOSFETs can turn off a current rather quickly but not at infinite speed. As the switching procedure does take some time, transient phenomena happen that need to be considered.

During this short period, when the device turns from conducting into blocking mode, the Reverse Biased Safe Operating Area needs to be respected at any time.

The limits are given by the current which is turned off and the voltage that appears across the device. The plot in Figure 3 schematically displays a turn-off event in detail.

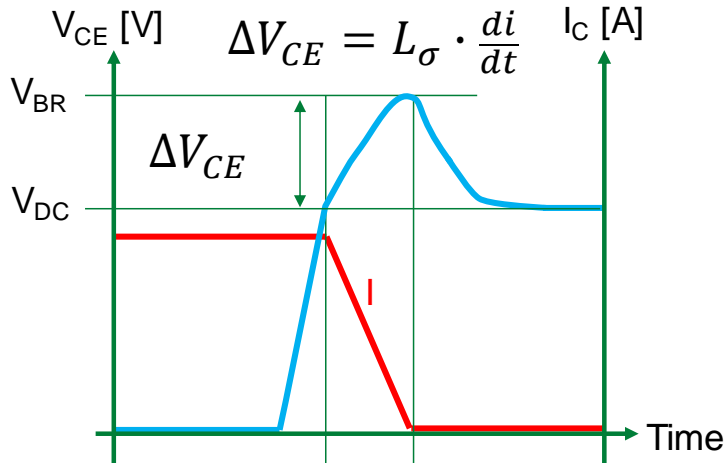

Figure 3. Voltage and current waveforms during a turn-off event

In the graph, it can clearly be seen that the voltage across the device first reaches the DC-link’s voltage level before the current starts declining. Because of the current change rate di/dt and the inherently contained stray inductances L_σ , the voltage spike ΔV_{CE} is added on top of the DC-link voltage. If this spike exceeds the device’s breakdown voltage V_{BR} – even for a very short period of time – the device will be destroyed.

The square-shaped Reverse Biased Safe Operating Area therefore is given by maximum current $I_{C,max}$ and the breakdown voltage V_{BR} , as depicted in Figure 4. Here too, the junction temperature poses a further limit.

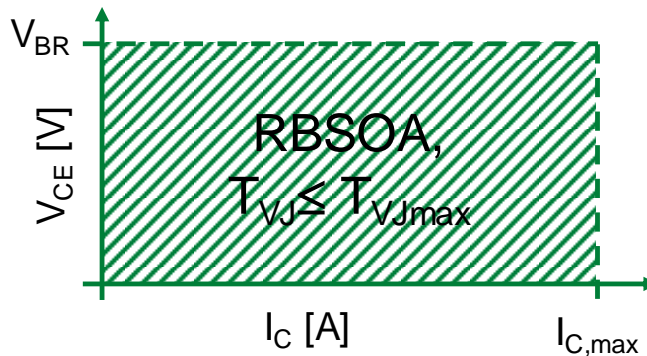

Figure 4. RBSOA-shape, limited by maximum current and breakdown voltage

3. Short-Circuit Safe Operating Area (SCSOA)

Devices that feature desaturation, like most IGBTs, can withstand short-circuit events for a distinct duration. Corresponding datasheets highlight this information as Short Circuit Safe Operating Area or SCSOA. Such a datasheet’s excerpt is given in Figure 5.

SCSOA	<i>short circuit safe operating area</i>	$V_{CEK} = 1200\text{ V}$				
t_{sc}	<i>short circuit duration</i>	$V_{CE} = 720\text{ V}; V_{GE} = \pm 15$	$T_{VJ} = 125^{\circ}\text{C}$		10	μs
I_{sc}	<i>short circuit current</i>	$R_G = 6.8\ \Omega; \text{non-repetitive}$		450		A

Figure 5. SCSOA information taken from the MDMA280UB1600PTED datasheet

The short circuit condition demands that the IGBT goes into desaturation. In this mode, no further charge carriers remain available which also limits the current. Typically, IGBTs limit the short-circuit current to about three to four times their rated current. In the example in Figure 5, the 160 A-device is expected to limit the short circuit current to 450 A. This situation is tolerable for 10 μs only and limited by thermal development.

4. Resulting challenges for the designer

Combining the two areas for Reverse Biased Safe Operation and Short Circuit Safe Operation into a single diagram reveals a gap between them, as pictured in Figure 6.

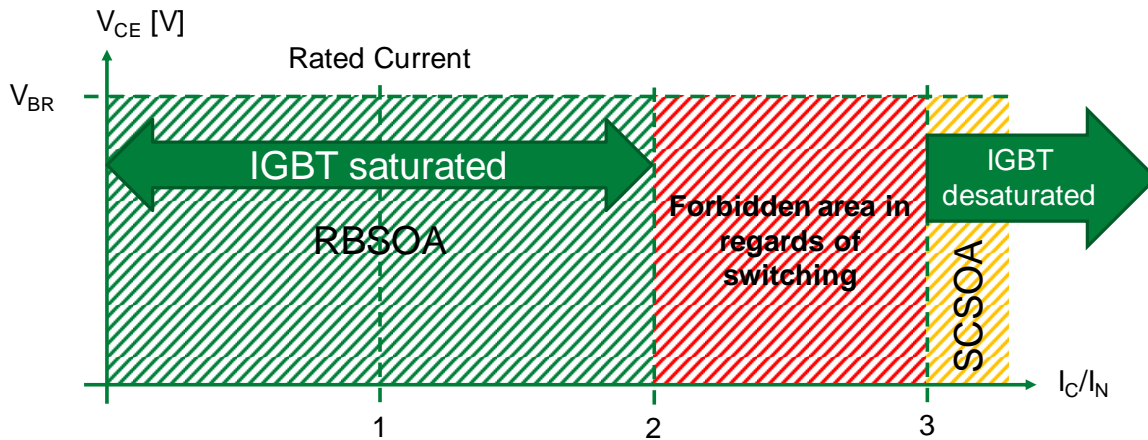

Figure 6. RBSOA, SCSOA, and the undefined region in between

Within the gap marked as forbidden area, located between twice and three times rated current, turning off the device is not allowed as it may lead to its destruction. The root cause of the destruction is found in very high local current densities, transiently forming during switching. The thermal limits in that case are reached already and additional burden due to switching losses leads to exceeding the limits. In turn, single cells on the chip fail and create a connection between collector and emitter. The current can no longer be turned off and the damage grows.

To overcome this situation, techniques to ensure that the IGBT reaches desaturation mode and enters the SCSOA can be used. The simplest way is to wait, instead of reacting on an overcurrent too quickly. Implementing a certain dead-time and fully exploit the 10 μs that the IGBT can withstand the conditions is a valid approach.

Further methods include the so-called 2-Level turn-off. The device is not turned off by immediately cancelling or even reversing the gate-emitter voltage. Instead, the gate-emitter voltage is first reduced to minimize the number of charge carriers available for current transport. This speeds up reaching the desaturation stage. A few microseconds later, when desaturation is reached, the gate-emitter voltage is set to zero or reversed. The device is then safely turned off within the SCSOA-specification.

This fact becomes particularly important when handling overcurrent situations.

From a given setup, measurements from a destructive turn-off event seen in Figure 7 were analyzed:

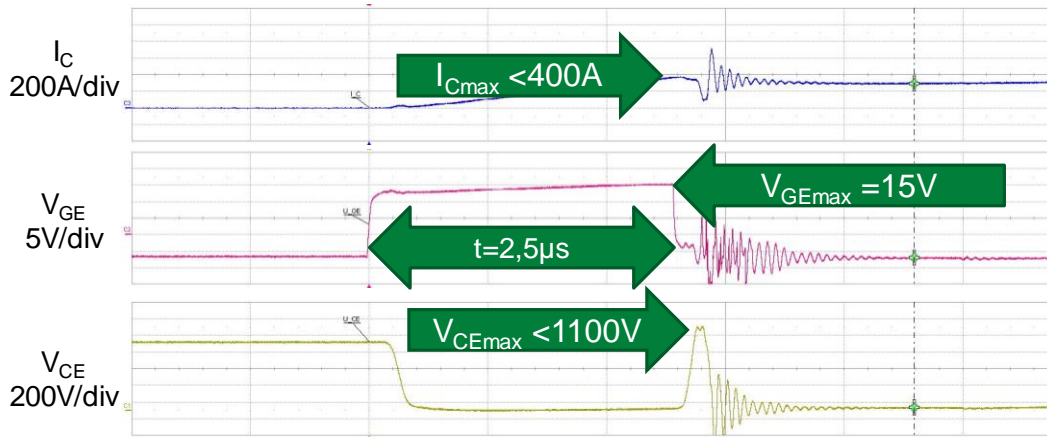

Figure 7. Measurement results from a destructive turn-off event

As the measurement reveals, the current turned off was well below the 450 A short-circuit limit. The gate-emitter-voltage was well-controlled, the time it took to turn off was below the 10 µs-limit and the overvoltage spike did not exceed the 1200 V the device is rated for. Still, the IGBT was destroyed, and the question raised, why so?

Entering the point of the turn-off into the diagram in Figure 6, the violation that happens becomes obvious in Figure 8:

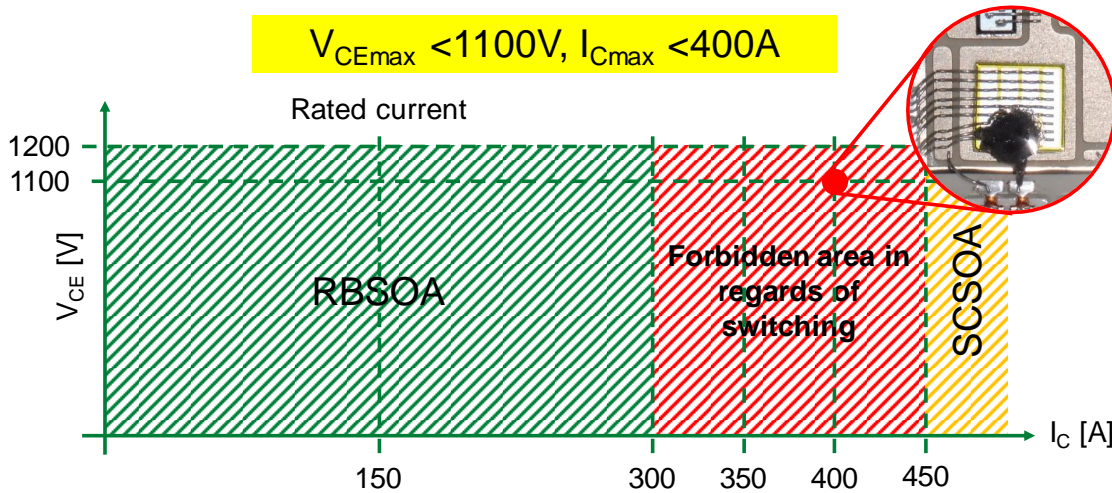

Figure 8. Locating the point of turn-off

Clearly, the switching event was done within the no-go-area with the destructive effect previously predicted.

To clear the situation, the control strategy for short circuit was changed. Instead of reacting on the overcurrent signal instantly and turn off after just 2.5 μs , a blanking time of about 6 μs was added.

Figure 9 represents the measurement done in the same setup.

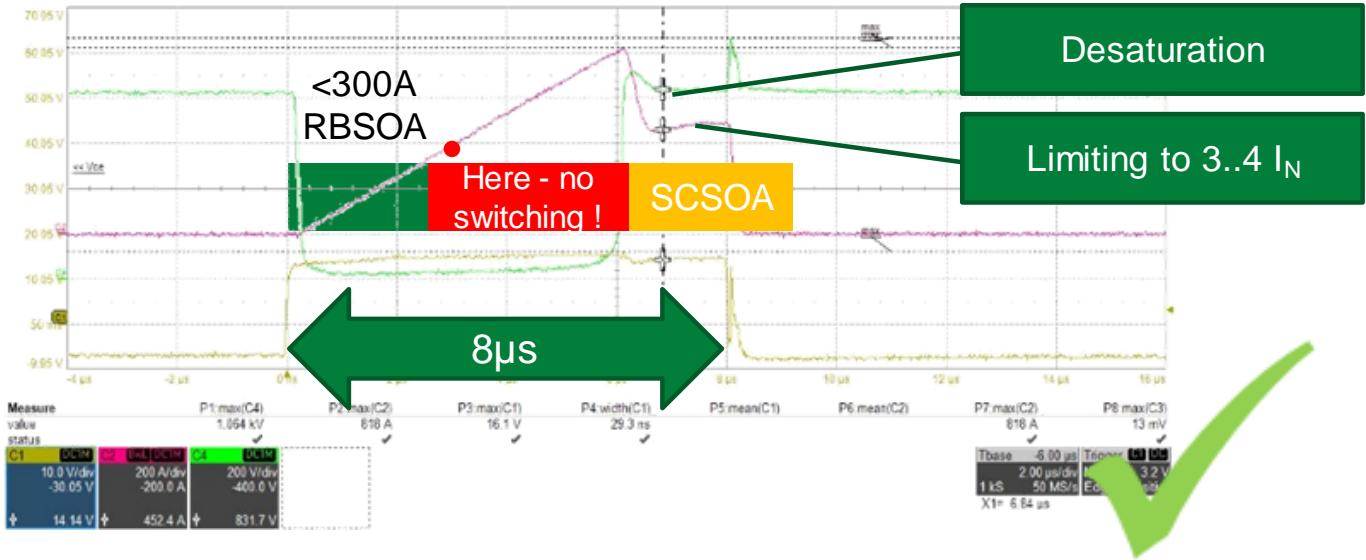

Figure 9. Properly turned off overcurrent or short-circuit event

While the red dot marks the former turn-off point, the current is now allowed to grow further. At first sight, this seems to worsen the situation as the losses and, as such, the chip temperature grows. However, after about 6 μs the IGBT reaches desaturation, enters the SCSOA and the turn-off after 8 μs is safely done without damaging the component.

MOSFETs, other than IGBTs, don't feature a dedicated SCSOA. At high currents, the MOSFET goes into linear operation as depicted in the FBSOA-diagram, so short-circuit and overcurrent events are covered by diagrams as given in Figure 2.

5. Conclusion

Handling overcurrent events, especially short circuit events, is challenging but manageable. Doing so while remaining within the given specifications can successfully be achieved.

Simply turning off a detected overcurrent as fast as possible may not be the best strategy as it may lead to damage caused by so-called RBSOA-exceedance. Ensuring that the IGBT reaches desaturation is a key factor in handling short circuit events with this technology.

For additional information please visit www.Littelfuse.com/powersemi

Disclaimer Notice - This document is provided by Littelfuse, Inc. ("Littelfuse") for informational and guideline purposes only. Littelfuse assumes no liability for errors or omissions in this document or for any of the information contained herein. Information is provided on an "as is" and "with all faults" basis for evaluation purposes only. Applications described are for illustrative purposes only and Littelfuse makes no representation that such applications will be suitable for the customer's specific use without further testing or modification. Littelfuse expressly disclaims all warranties, whether express, implied or statutory, including but not limited to the implied warranties of merchantability and fitness for a particular purpose, and non-infringement. It is the customer's sole responsibility to determine suitability for a particular system or use based on their own performance criteria, conditions, specific application, compatibility with other components, and environmental conditions. Customers must independently provide appropriate design and operating safeguards to minimize any risks associated with their applications and products.

Littelfuse products are not designed for, and shall not be used for, any purpose (including, without limitation, automotive, military, aerospace, medical, life-saving, life-sustaining or nuclear facility applications, devices intended for surgical implant into the body, or any other application in which the failure or lack of desired operation of the product may result in personal injury, death, or property damage) other than those expressly forth in applicable Littelfuse product documentation. Littelfuse shall not be liable for any claims or damages arising out of products used in applications not expressly intended by Littelfuse as set forth in applicable Littelfuse documentation.

Read complete Disclaimer Notice at www.littelfuse.com/disclaimer-electronics