



IMPROVED CERTIFICATIONS SEARCH TOOL. REGISTER NOW!

[LEARN MORE](#)

QQQX2.E153432

Electrically Isolated Semiconductor Devices - Component

If you notice a change to your QQQX2 Listing Card, click [here](#) to learn more.

[Page Bottom](#)

Electrically Isolated Semiconductor Devices - Component

[See General Information for Electrically Isolated Semiconductor Devices - Component](#)

IXYS CORP

E153432

1590 BUCKEYE DR
MILPITAS, CA 95035-7418 USA

Power Switching Semi-Conductors, Model(s) CS followed by additional letters and/or numbers, followed by M.

Power Switching Semi-Conductors, Model(s) D followed by additional letters and/or numbers, followed by M.

Power Switching Semi-Conductors, Model(s) D, C, M or I followed by additional letters and/or numbers, followed by PN or PM.

Power Switching Semi-Conductors, Model(s) DS followed by additional letters and/or numbers, followed by M.

Power Switching Semi-Conductors, Model(s) IX followed by additional letters and/or numbers, followed by M.

Power Switching Semi-Conductors, Model(s) IX followed by an upper case letter, followed by N, followed by any number 01 through 99999, followed by additional numbers and letters.

Semi-conductor diodes, thyristors, IGBT or MOSFETS, ISO247 package, Model(s) IX J Series IX, followed by one letter B, C, D, E, F, G, H, K, L, S, T, U, X, or Y, followed by J, may be followed by 01-09, 1R1-1R9, 1-9, 10-99, or 100-999 may be followed by N or P, may be followed by 01-10, 1-99 or 100-800, may be followed by up to six alpha-numeric characters.

Semi-conductor diodes, thyristors, IGBT or MOSFETS, ISOPLUS I4-PAC package, Model(s) IX F Series IX, followed by one letter B, C, D, E, F, G, H, K, L, S, T, U, X, or Y, followed by L, may be followed by 01-09, 1R1-1R9, 1-9, 10-99, or 100-999 may be followed by N or P, may be followed by 01-10, 1-99 or 100-800, may be followed by up to six alpha-numeric characters.

Semi-conductor diodes, thyristors, IGBT or MOSFETS, ISOPLUS SMPD package, Model(s) IXM2001 IX, followed by one letter B, C, D, E, F, G, H, K, L, S, T, U, X, or Y, followed by L, may be followed by 01-09, 1R1-1R9, 1-9, 10-99, or 100-999 may be followed by N or P, may be followed by 01-10, 1-99 or 100-800, may be followed by up to six alpha-numeric characters.

Semi-conductor diodes, thyristors, IGBT or MOSFETS, ISOPLUS SMPD package, Model(s) MDIX4X30N65B3 IX, followed by one letter B, C, D, E, F, G, H, K, L, S, T, U, X, or Y, followed by L, may be followed by 01-09, 1R1-1R9, 1-9, 10-99, or 100-999 may be followed by N or P, may be followed by 01-10, 1-99 or 100-800, may be followed by up to six alpha-numeric characters.

Semi-conductor diodes, thyristors, IGBT or MOSFETS, ISOPLUS SMPD package, Model(s) MMIX IX, followed by one letter B, C, D, E, F, G, H, K, L, S, T, U, X, or Y, followed by L, may be followed by 01-09, 1R1-1R9, 1-9, 10-99, or 100-999 may be followed by N or P, may be followed by 01-10, 1-99 or 100-800, may be followed by up to six alpha-numeric characters.

Semi-conductor diodes, thyristors, IGBT or MOSFETS, ISOPLUS SMPD package, Model(s) MMIX1992 IX, followed by one letter B, C, D, E, F, G, H, K, L, S, T, U, X, or Y, followed by L, may be followed by 01-09, 1R1-1R9, 1-9, 10-99, or 100-999 may be followed by N or P, may be followed by 01-10, 1-99 or 100-800, may be followed by up to six alpha-numeric characters.

Semi-conductor diodes, thyristors, IGBT or MOSFETS, ISOPLUS220 package, Model(s) IX followed by one letter B, C, D, E, F, G, H, K, L, S, T, U, X, or Y, followed by C, may be followed by 01-09, 1R1-1R9, 1-9, 10-99, or 100-999 may be followed by N or P, may be followed by 01-10, 1-99 or 100-800, may be followed by up to six alpha-numeric characters.

Semi-conductor diodes, thyristors, IGBT or MOSFETS, ISOPLUS264 package, Model(s) IX L Series IX, followed by one letter B, C, D, E, F, G, H, K, L, S, T, U, X, or Y, followed by L, may be followed by 01-09, 1R1-1R9, 1-9, 10-99, or 100-999 may be followed by N or P, may be followed by 01-10, 1-99 or 100-800, may be followed by up to six alpha-numeric characters.

Semi-conductor diodes, thyristors, IGBT or MOSFETS, SSMPD package, Model(s) MMJX MMJX, followed by 1, 2, 3, followed by B, C, D, E, F, G, H, K, L, S, T, U, X, or Y, followed by number 1-999, followed by N or P, followed by number 1-800, may be followed by up to 6 alpha-numeric characters.

Semi-conductor diodes, thyristors, or MOSFETS, 247 hole-less package, Model(s) DSE (a), IXBR (a), IXGR (a), IXLR (a), IXSR (a), IXTR (a)

Semi-conductor diodes, thyristors, or MOSFETS, ISOPLUS247 package, Model(s) IX followed by one letter B, C, D, E, F, G, H, K, L, S, T, U, X, or Y, followed by R, may be followed by 01-09, 1R1-1R9, 1-9, 10-99, or 100-999 may be followed by N or P, may be followed by 01-10, 1-99 or 100-800, may be followed by up to six alpha-numeric characters.

(a) - Followed by up to 10 numbers and letters.

Marking: Company name and model designation.

Last Updated on 2018-08-29

[Questions?](#)

[Print this page](#)

[Terms of Use](#)

[Page Top](#)

© 2018 UL LLC

The appearance of a company's name or product in this database does not in itself assure that products so identified have been manufactured under UL's Follow-Up Service. Only those products bearing the UL Mark should be considered to be Certified and covered under UL's Follow-Up Service. Always look for the Mark on the product.

UL permits the reproduction of the material contained in the Online Certification Directory subject to the following conditions: 1. The Guide Information, Assemblies, Constructions, Designs, Systems, and/or Certifications (files) must be presented in their entirety and in a non-misleading manner, without any manipulation of the data (or drawings). 2. The statement "Reprinted from the Online Certifications Directory with permission from UL" must appear adjacent to the extracted material. In addition, the reprinted material must include a copyright notice in the following format: "© 2018 UL LLC".

Handling and Mounting Littelfuse miniBLOC - SOT227B

Objectives

This application note discusses mounting and handling for Littelfuse power semiconductors in SOT227B package, the miniBLOC, as depicted in Figure 1. Information is provided focusing on special precautions to be considered during mounting.

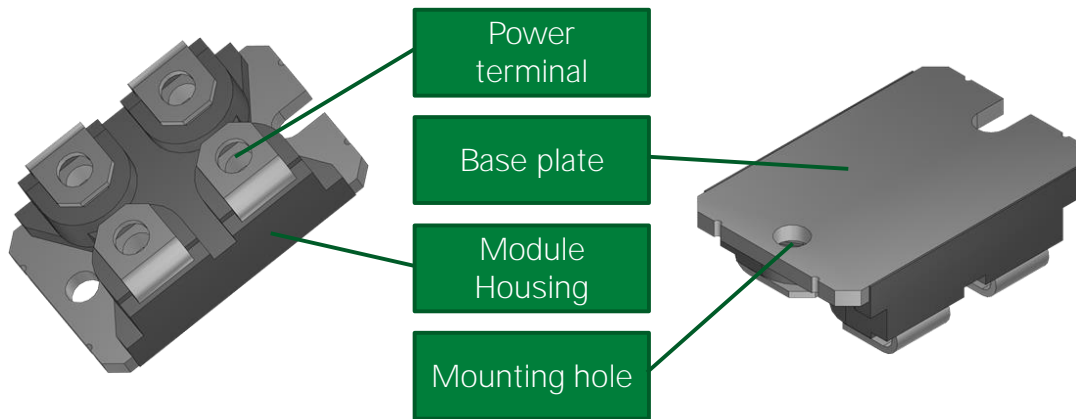

Figure 1: Littelfuse miniBLOC, in SOT227B

Applications

- Industrial motor drives
- PV inverters
- UPS systems
- DC-DC converters
- Commercial vehicles

Target Audience

This document is intended for potential adopters of power semiconductors who want to determine the appropriate mounting and cooling solution to ensure proper package mounting and thermal performance.

Contact Information

For more information on the topic of mounting this kind of device, contact the Littelfuse Power Semiconductor team of product and applications experts:

- PowerSemiSupport@Littelfuse.com

Table of Contents

1. Introduction	4
2. Recommended Heat Sink Assembly	4
2.1. Heat Sink Preparation	5
2.2. Use of Thermal Interface Materials	5
2.3. Detailed Mounting Procedure.....	6
3. Further Mechanical Aspects.....	7
3.1. Metric Thread, Imperial Thread, Self-tapping Screws.....	7
3.2. Mounting the Electronics and DC-link Components.....	7
3.3. Insulation Management	8
4. Conclusion.....	9

List of Figures

Figure 1: Littelfuse miniBLOC, in SOT227B	1
Figure 2. Mounting the miniBLOC to a Heat Sink	4
Figure 3. Heat Sink's Surface Requirements to Mount Power Modules	5
Figure 4. Improving Thermal Transfer by using Thermal Interface Material (TIM)	5
Figure 5: Bolting down the screw – Incorrect and Correct Method.....	6
Figure 6: Phillips-style Screws and Captivated Washers acc. to ISO 10644.....	7
Figure 7: Module assembly with Power-Terminals attached.....	7

1. Introduction

The miniBLOC is the intermediate link between discrete power devices like the TO-263 and power semiconductor modules like Littelfuse Y-series. Though it features a DCB-substrate to carry the dies, the molded housing structure characterizes it to be a discrete component rather than a power module. The internal DCB substrate inherently offers electrical insulation, allowing for mounting of several miniBLOCs to the same heat sink without additional means of isolation. The base plate in turn acts as large-area interface between the semiconductor and a heat sink.

The package provides features beneficial for power electronic applications. These include:

- High electric insulation strength
- High thermal performance
- Current ratings to support applications up to hundreds of kilowatts
- Internal construction is designed to reduce stray inductance and parasitic capacitances, leading to improved EMI-performance

With the four terminals, the miniBLOC is available in a variety of technologies including IGBT, thyristor, Si- and SiC- diode and MOSFET in voltage classes from 40 to 2500 V and current ratings up to 600A.

There are a few miniBLOCs, such as the DSEC 240-04A and the DSEC 240-06A, that feature a non-isolated construction and an electrically active base plate. These are diode devices, designed for special purposes. Despite the slightly different internal construction, the recommendations made in this application note are valid for these types as well.

2. Recommended Heat Sink Assembly

Semiconductor power devices are designed to be mounted onto a heat sink, most often using screws. A layer of Thermal Interface Material (TIM) is needed to ensure a high thermal conductivity from the dice to the heatsink. After the application of thermal interface material is completed, the component can be mounted to a heatsink by mounting screws. An example of a SOT227B assembly is sketched in Figure 2.

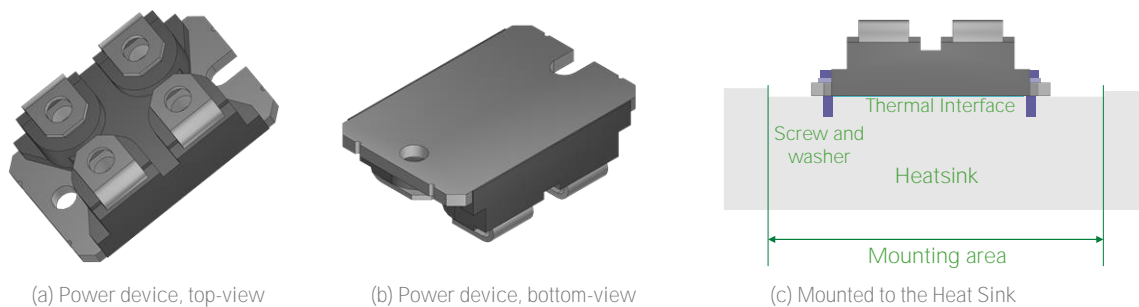

Figure 2. Mounting the miniBLOC to a Heat Sink

2.1. Heat Sink Preparation

When the package is mounted, the base plate becomes the crucial surface for thermal management. A heatsink needs to be mounted for heat dissipation, as depicted in Figure 2. There are dedicated mounting holes in the package; the proper set of dimensions for the drill-hole-pattern is given in the correlating datasheet.

To ensure a low value of thermal resistance, the contact surface of the heat sink must be flat, even, and clean. For the mounting area, the surface quality must achieve or exceed the values given in Figure 3.

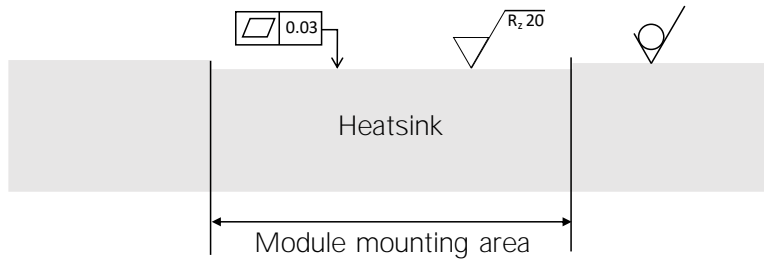

Figure 3. Heat Sink's Surface Requirements to Mount Power Modules

Prior to mounting, cleaning all surfaces with a suitable cleaning agent is advised.

2.2. Use of Thermal Interface Materials

The use of Thermal Interface Materials (TIM) is mandatory to achieve a suitable contact between the device's base and the heat sink surface. It reduces the thermal resistance case-to-heatsink, R_{thch} . Thermal interface materials are available as thermal pad and thermal grease or compound. Unlike the discrete packages where the copper cooling pad is usually electrically active, packages with solid metal base plates internally feature a DCB structure which uses a layer of ceramic as electrical isolation. With up to 4500 V isolation voltage, the packages provide the option to use electrically non-isolated thermal interface materials. It is not recommended to use an interface material with isolation such as silicone-pads sometimes used for discrete packaged devices. These materials inherently exhibit a higher thermal resistance compared to thermal greases or conductive thermal pads.

The thermal interface materials should be applied evenly to the device base plate or the heat sink surface. Ideally, screen printing is used to achieve accurate and reproduceable results. A screen thickness of 100µm with a fill-factor of 70-80% and a regular pattern of honeycomb-shaped openings has proven to be a reasonable approach.

As no electrical isolation is required from the TIM layer, it is recommended to have a very thin layer of TIM so that the material just fills the gaps and voids between the device's copper pad and the heatsink, as seen in Figure 4.

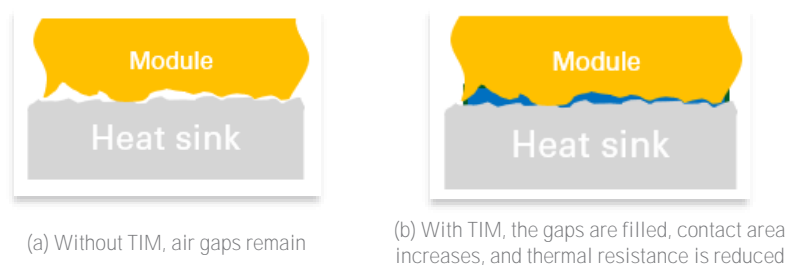

Figure 4. Improving Thermal Transfer by using Thermal Interface Material (TIM)

If a solid thermal pad is considered, softer materials with high thermal conductivity are preferred to better fill the gaps. The thermal pad should be as thin as possible to provide the lowest thermal resistance. The mounting mechanism using screws provides proper pressure on the thermal interface material to ensure a low value of thermal resistance. A procedure to create a proper stencil and set up a basic stencil-printing equipment is described in detail in the application note *Basics of Stencil Generation to Apply Thermal Grease to Power Semiconductors*, which can be downloaded from the Littelfuse website.

2.3. Detailed Mounting Procedure

Mounting the module by screws inherently achieves mounting forces in a range of kilonewton. Though the base plate is highly resistant to pressure, the internal DCB-structure is very sensitive towards bending. Therefore, careful handling and step-by-step tightening of the screws is mandatory to achieve the desired pressure distribution and prevent bending the internal DCB. Besides the mounting forces, an even distribution of thermal interface material is important. Uneven distribution, particularly with higher amount of material in the center of the module, may also lead to high local forces that could damage the DCB inside the power module.

Using solid sheets as thermal interface material is not a recommended solution as these typically remain too thick and limit the module’s thermal performance. Additionally, they may lead to further issues during mounting.

Figure 5(a) illustrates that the module lifts on one side in case the first screw is bolted down too much and Figure 5(b) and Figure 5(c) show a two-step sequence to prevent this from happening.

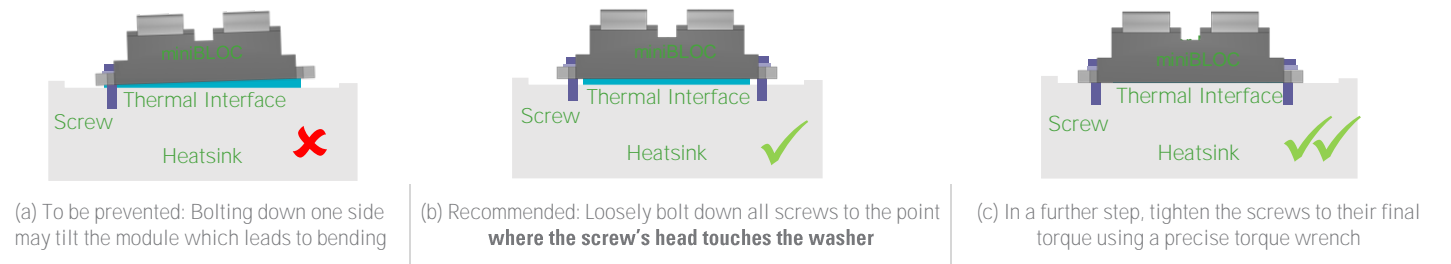

Figure 5: Bolting down the screw – Incorrect and Correct Method

The tightening procedure is summarized in Table 1.

Table 1: Mounting Sequence to mount SOT227B

Package Type	Screw Diameter	Step 1	Step 2	Step 3	Step 4
SOT227B	4 mm	Bolt down both screws, so that the screws’ heads get the washers to contact the base plate	Apply 0.5 Nm to both screws	Wait for the assembly to settle. Settling time depends on the TIM in use and varies from 5-10 minutes	Apply no more than 1.5 Nm to both screws

In case imperial screws are preferred for mounting, a screw 8-36 is the closest replacement for M4. The mounting torque needs to be limited to not exceed 11.5 lb-in

3. Further Mechanical Aspects

Besides the data and procedures to mount power electronic components, influences that arise from mechanical parts and physics need detailed attention. Some details that appear to be of minor impact can lead to unexpected effects with highly detrimental consequences.

3.1. Metric Thread, Imperial Thread, Self-tapping Screws

The recommended material for mounting the module to the heat sink is a metric screw with spring-washer and captivated washer as described by ISO 10644. Zinc- or nickel-plated steel screws with a property class 6.8 or higher, as depicted in Figure 6, are recommended.



Figure 6: Phillips-style Screws and Captivated Washers acc. to ISO 10644

Using screws with imperial scale is an option too. However, due to the different diameters and thread's pitch, the ratio between turning angle, torque, and resulting mounting forces also changes. Purely translating newton meter (Nm) into pound inches (lb-in) might result in misleading values. Individual verification of the result is advised to verify proper pressure and pressure distribution is achieved.

In case self-tapping screws like those described in DIN7504-K and ISO15480 are preferred, dedicated tests are needed to correlate torque, turning angle, and mounting force. As the torque mainly depends on the drill-hole's diameter and the heat sink material, no general recommendation can be made. Using washers and spring-washers in combination with self-tapping screws is advised.

3.2. Mounting the Electronics and DC-link Components

Power modules are robust regarding pressure applied, but highly sensitive towards pulling forces. Pulling forces can be a consequence of dynamic influences like shock and vibration but as well result from the combination of materials used in the construction and their tolerances.

A mechanical assembly must ensure that the resulting forces to the terminals remain directed as pictured in Figure 7.

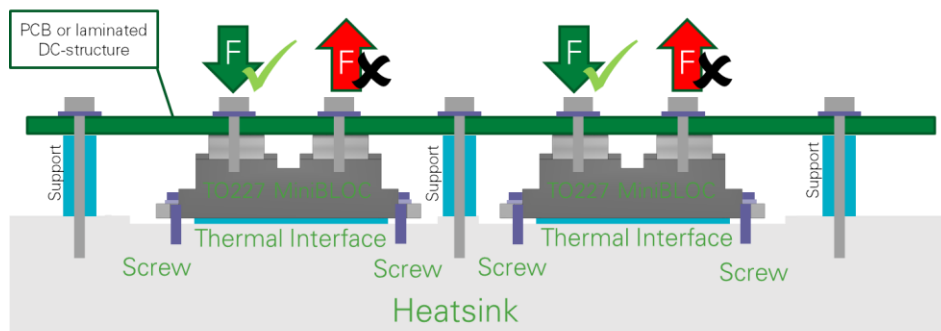

Figure 7: Module assembly with Power-Terminals attached

A total force of up to 100N applying pressure to the module is tolerable while no pulling force may remain after mounting is complete. To achieve this, properly dimensioned supports must be installed. These prevent static forces as well as dynamic events from reaching the terminals. Including all tolerances, the supports' length needs to remain below the height of the module in use. Larger components like DC-link capacitors, output terminals, or heavy current sensors require additional support. In case of vibration, undampened oscillating masses may inject destructive forces into the power component.

To mount the DC-link-structure to the modules, either as PCB or laminated copper plates, 4 suitable screws are delivered with each miniBLOC, a tube with 10 devices contains 40 screws. In case a different type of screw is desired, the screws mandatorily need to comply with the information given in the data sheet. The maximum length of the screws depends on the thickness of the structure mounted on top of the modules. Caution is advised as too long screws can damage the housing, enter electrically sensitive areas, and cause severe damage.

As the nuts embedded in the modules feature metric threads, the use of screws according to imperial scale is not an option for mounting the power terminals. The nuts are held in place by the housing. Applying too high torque can lead to damage of the housing and in turn to loss of function.

The terminal screws can support a maximum torque of 1.1 Nm or 9 lb-in. Especially in combination with oils used to prevent corrosion, the friction during mounting can change massively, leading to a distortion in the ratio of torque and turning angle. The same applies when using adhesive-based thread lockers.

When handling sub-assemblies, supporting the whole setup to move it is recommended. Using the bus bar or the PCB as a handle includes a high risk of applying pulling forces and therefore needs to be prevented.

If a module is being replaced, ensure there is no contamination in the threaded hole; for example, thermal paste that has been solvent washed into the threads, as this may limit the screws' engagement resulting in false fastener tension and module clamping force. In situations where blind holes are not required for maintaining corrosion or pressure sealing performance, threaded through holes can be used as these can be brushed, washed clean, and inspected easily.

3.3. Insulation Management

Two major parameters require to be considered when PCB-layouts and DC-link-components are designed:

- Clearance – the shortest possible distance between two points, and
- Creepage distance – the shortest path from one point to another point along an uninterrupted line on solid material

Particularly when using laminated bus bar structures, isolating the layers from each other remains an important task.

In high-voltage environments, arcing between different voltage levels must be prevented. Arcing takes place over air-gaps – clearance distances – so the voltage level expected in the final system defines the distance between pads and traces as well as between active areas and heat sinks or other grounded parts. Even if the clearance between two points is chosen to be high enough, the insulation strength can be reduced by conductive particles over a longer period. This depends on the degree of pollution, which relates to the ambient conditions the device is used in.

IEC60664-1 gives an insight about the relevant conditions that need to be considered to determine the creepage and clearance distances in a targeted design.

4. Conclusion

Littelfuse miniBLOC devices with their base plate and molded housing structure are mechanically robust components. Still, care needs to be taken to not bend the module during the mounting process and a mechanical arrangement must be designed to prevent pulling forces at the terminals. Applying thermal interface material by a well-controlled screen-printing process further helps to reduce unwanted mechanical stress to the device.

If these aspects are considered, mounting the devices can successfully be done by implementing established procedures and processes.

Revision History		
Version	Date	Changes
22.08a	August 2022	Initial version created for release

For additional information please visit www.Littelfuse.com/powersemi

Disclaimer Notice - This document is provided by Littelfuse, Inc. ("Littelfuse") for informational and guideline purposes only. Littelfuse assumes no liability for errors or omissions in this document or for any of the information contained herein. Information is provided on an "as is" and "with all faults" basis for evaluation purposes only. Applications described are for illustrative purposes only and Littelfuse makes no representation that such applications will be suitable for the customer's specific use without further testing or modification. Littelfuse expressly disclaims all warranties, whether express, implied or statutory, including but not limited to the implied warranties of merchantability and fitness for a particular purpose, and non-infringement. It is the customer's sole responsibility to determine suitability for a particular system or use based on their own performance criteria, conditions, specific application, compatibility with other components, and environmental conditions. Customers must independently provide appropriate design and operating safeguards to minimize any risks associated with their applications and products.

Littelfuse products are not designed for, and shall not be used for, any purpose (including, without limitation, automotive, military, aerospace, medical, life-saving, life-sustaining or nuclear facility applications, devices intended for surgical implant into the body, or any other application in which the failure or lack of desired operation of the product may result in personal injury, death, or property damage) other than those expressly forth in applicable Littelfuse product documentation. Littelfuse shall not be liable for any claims or damages arising out of products used in applications not expressly intended by Littelfuse as set forth in applicable Littelfuse documentation.

Read complete Disclaimer Notice at www.littelfuse.com/disclaimer-electronics

XPT™ 650V GenX4™ IXXN110N65C4H1 w/ Sonic Diode

Extreme Light Punch Through
IGBT for 20-60kHz Switching

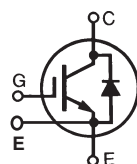

$$\begin{aligned} V_{CES} &= 650V \\ I_{C110} &= 110A \\ V_{CE(sat)} &\leq 2.35V \\ t_{fi(typ)} &= 35ns \end{aligned}$$

SOT-227B, miniBLOC
E153432

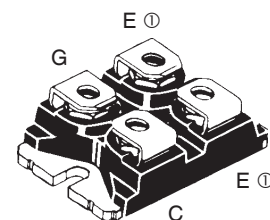

G = Gate, C = Collector, E = Emitter
Ⓢ either emitter terminal can be used as
Main or Kelvin Emitter

Symbol	Test Conditions	Maximum Ratings	
V_{CES}	$T_J = 25^\circ\text{C to } 175^\circ\text{C}$	650	V
V_{CGR}	$T_J = 25^\circ\text{C to } 175^\circ\text{C}, R_{GE} = 1M\Omega$	650	V
V_{GES}	Continuous	± 20	V
V_{GEM}	Transient	± 30	V
I_{C25}	$T_C = 25^\circ\text{C}$ (Chip Capability)	210	A
I_{C25}	Terminal Current Limit	200	A
I_{C110}	$T_C = 110^\circ\text{C}$	110	A
I_{F110}	$T_C = 110^\circ\text{C}$	70	A
I_{CM}	$T_C = 25^\circ\text{C}, 1\text{ms}$	670	A
SSOA (RBSOA)	$V_{GE} = 15V, T_{VJ} = 150^\circ\text{C}, R_G = 2\Omega$ Clamped Inductive Load	$I_{CM} = 220$ @ $V_{CE} \leq V_{CES}$	A
t_{sc} (SCSOA)	$V_{GE} = 15V, V_{CE} = 360V, T_J = 150^\circ\text{C}$ $R_G = 82\Omega$, Non Repetitive	10	μs
P_C	$T_C = 25^\circ\text{C}$	750	W
T_J		-55 ... +175	$^\circ\text{C}$
T_{JM}		175	$^\circ\text{C}$
T_{stg}		-55 ... +175	$^\circ\text{C}$
V_{ISOL}	50/60Hz $I_{ISOL} \leq 1\text{mA}$	$t = 1\text{min}$ $t = 1\text{s}$	2500 3000 V~ V~
M_d	Mounting Torque Terminal Connection Torque	1.5/13 1.3/11.5	Nm/lb.in Nm/lb.in
Weight		30	g

Features

- International Standard Package
- miniBLOC, with Aluminium Nitride Isolation
- 2500V~ Isolation Voltage
- Anti-Parallel Sonic Diode
- Optimized for 20-60kHz Switching
- Square RBSOA
- Short Circuit Capability
- High Current Handling Capability

Advantages

- High Power Density
- Low Gate Drive Requirement

Applications

- Power Inverters
- UPS
- Motor Drives
- SMPS
- PFC Circuits
- Battery Chargers
- Welding Machines
- Lamp Ballasts
- High Frequency Power Inverters

Symbol	Test Conditions ($T_J = 25^\circ\text{C}$, Unless Otherwise Specified)	Characteristic Values		
		Min.	Typ.	Max.
BV_{CES}	$I_C = 250\mu\text{A}, V_{GE} = 0V$	650		V
$V_{GE(th)}$	$I_C = 4\text{mA}, V_{CE} = V_{GE}$	4.0		6.5 V
I_{CES}	$V_{CE} = V_{CES}, V_{GE} = 0V$ $T_J = 150^\circ\text{C}$			50 μA 3 mA
I_{GES}	$V_{CE} = 0V, V_{GE} = \pm 20V$			± 100 nA
$V_{CE(sat)}$	$I_C = 110A, V_{GE} = 15V$, Note 1 $T_J = 150^\circ\text{C}$	2.06 2.50		2.35 V V

Symbol Test Conditions ($T_J = 25^\circ\text{C}$ Unless Otherwise Specified)		Characteristic Values		
		Min.	Typ.	Max.
g_{fs}	$I_C = 60\text{A}, V_{CE} = 10\text{V}$, Note 1	30	52	S
C_{ies}	$V_{CE} = 25\text{V}, V_{GE} = 0\text{V}, f = 1\text{MHz}$		5500	pF
C_{oes}			440	pF
C_{res}			80	pF
$Q_{g(on)}$	$I_C = 110\text{A}, V_{GE} = 15\text{V}, V_{CE} = 0.5 \cdot V_{CES}$		167	nC
Q_{ge}			44	nC
Q_{gc}			63	nC
$t_{d(on)}$	Inductive load, $T_J = 25^\circ\text{C}$ $I_C = 55\text{A}, V_{GE} = 15\text{V}$ $V_{CE} = 400\text{V}, R_G = 2\Omega$ Note 2		30	ns
t_{ri}			45	ns
E_{on}			2.50	mJ
$t_{d(off)}$			110	ns
t_{fi}			35	ns
E_{off}		0.63	1.05	mJ
$t_{d(on)}$	Inductive load, $T_J = 150^\circ\text{C}$ $I_C = 55\text{A}, V_{GE} = 15\text{V}$ $V_{CE} = 400\text{V}, R_G = 2\Omega$ Note 2		26	ns
t_{ri}			45	ns
E_{on}			3.55	mJ
$t_{d(off)}$			120	ns
t_{fi}			40	ns
E_{off}		0.90	mJ	
R_{thJC}			0.20	$^\circ\text{C/W}$
R_{thCS}		0.05		$^\circ\text{C/W}$

SOT-227B miniBLOC (IXXN)

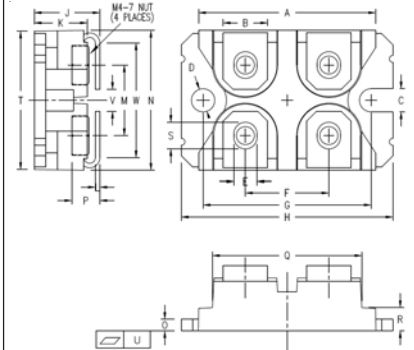

SYM	INCHES		MILLIMETERS	
	MIN	MAX	MIN	MAX
A	1.240	1.255	31.50	31.88
B	.307	.323	7.80	8.20
C	.161	.169	4.09	4.29
D	.161	.169	4.09	4.29
E	.161	.169	4.09	4.29
F	.587	.595	14.91	15.11
G	1.186	1.193	30.12	30.30
H	1.489	1.505	37.80	38.23
J	.460	.481	11.68	12.22
K	.351	.378	8.92	9.60
L	.030	.033	0.76	0.84
M	.496	.506	12.60	12.85
N	.990	1.001	25.15	25.42
O	.078	.084	1.98	2.13
P	.195	.235	4.95	5.97
Q	1.045	1.059	26.54	26.90
R	.155	.174	3.94	4.42
S	.186	.191	4.72	4.85
T	.968	.987	24.59	25.07
U	-.002	.004	-0.05	0.1
V	.130	.180	3.30	4.57
W	.780	.830	19.81	21.08

Reverse Sonic Diode (FRD)

Symbol Test Conditions ($T_J = 25^\circ\text{C}$ Unless Otherwise Specified)		Characteristic Values		
		Min.	Typ.	Max.
V_F	$I_F = 100\text{A}, V_{GE} = 0\text{V}$, Note 1 $T_J = 150^\circ\text{C}$		1.7 1.8	V V
I_{RM}	$I_F = 100\text{A}, V_{GE} = 0\text{V}, T_J = 150^\circ\text{C}$ $-di_F/dt = 1500\text{A}/\mu\text{s}, V_R = 300\text{V}$		95	A
t_{rr}			100	ns
R_{thJC}			0.42	$^\circ\text{C/W}$

Notes:

1. Pulse test, $t \leq 300\mu\text{s}$, duty cycle, $d \leq 2\%$.
2. Switching times & energy losses may increase for higher V_{CE} (clamp), T_J or R_G .

IXYS Reserves the Right to Change Limits, Test Conditions, and Dimensions.

IXYS MOSFETs and IGBTs are covered by one or more of the following U.S. patents:	4,835,592	4,931,844	5,049,961	5,237,481	6,162,665	6,404,065 B1	6,683,344	6,727,585	7,005,734 B2	7,157,338B2
	4,860,072	5,017,508	5,063,307	5,381,025	6,259,123 B1	6,534,343	6,710,405 B2	6,759,692	7,063,975 B2	
	4,881,106	5,034,796	5,187,117	5,486,715	6,306,728 B1	6,583,505	6,710,463	6,771,478 B2	7,071,537	

Fig. 1. Output Characteristics @ $T_J = 25^\circ\text{C}$

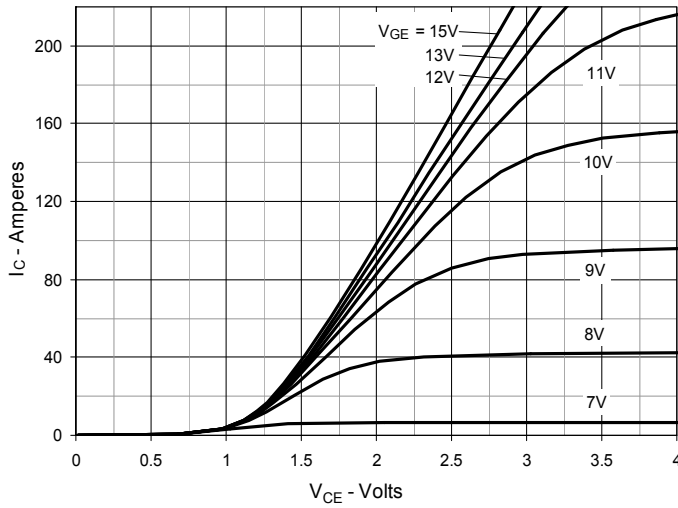

Fig. 2. Extended Output Characteristics @ $T_J = 25^\circ\text{C}$

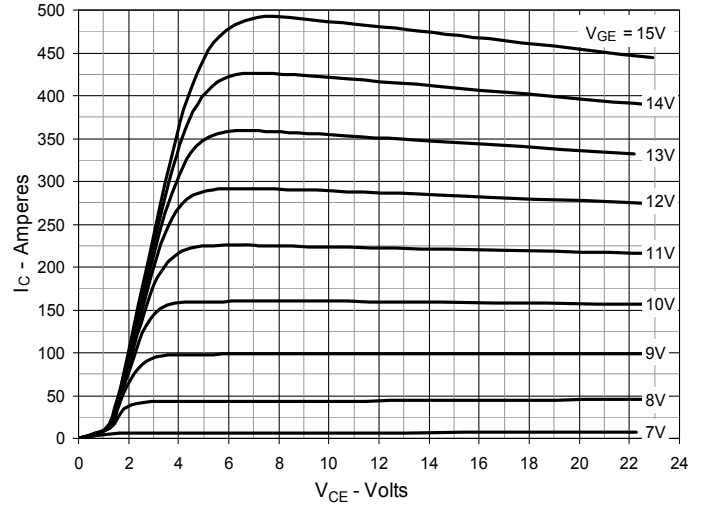

Fig. 3. Output Characteristics @ $T_J = 150^\circ\text{C}$

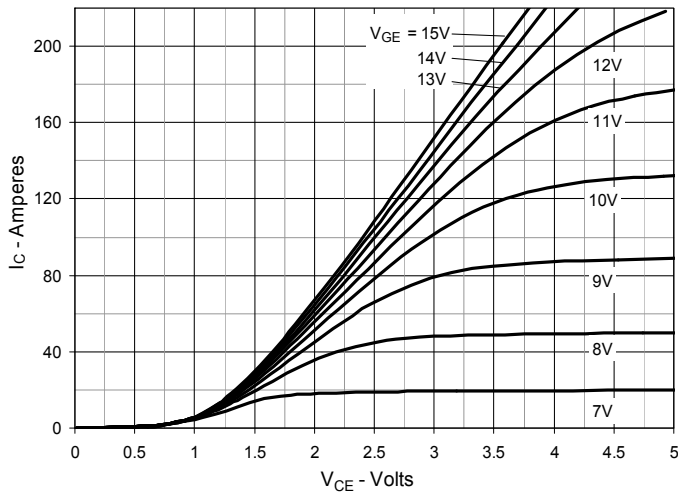

Fig. 4. Dependence of $V_{CE(sat)}$ on Junction Temperature

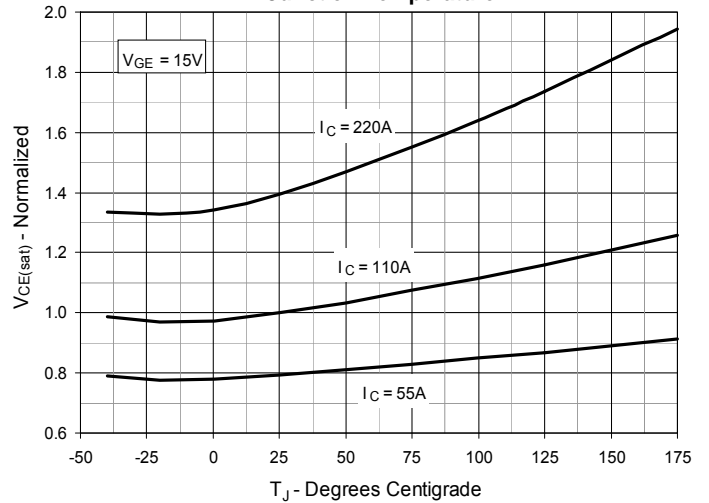

Fig. 5. Collector-to-Emitter Voltage vs. Gate-to-Emitter Voltage

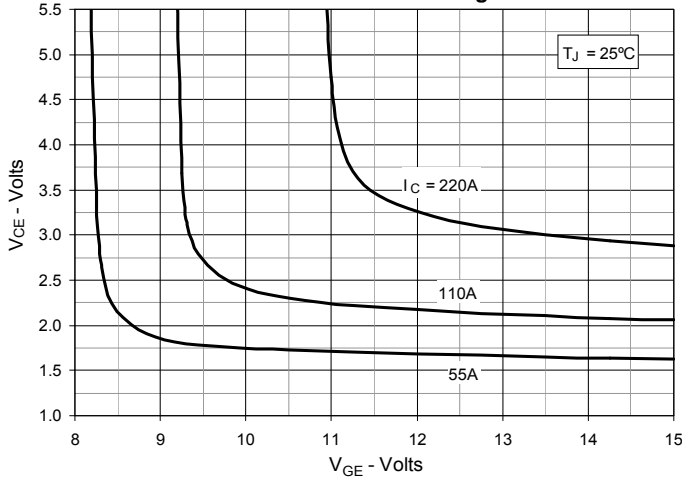

Fig. 6. Input Admittance

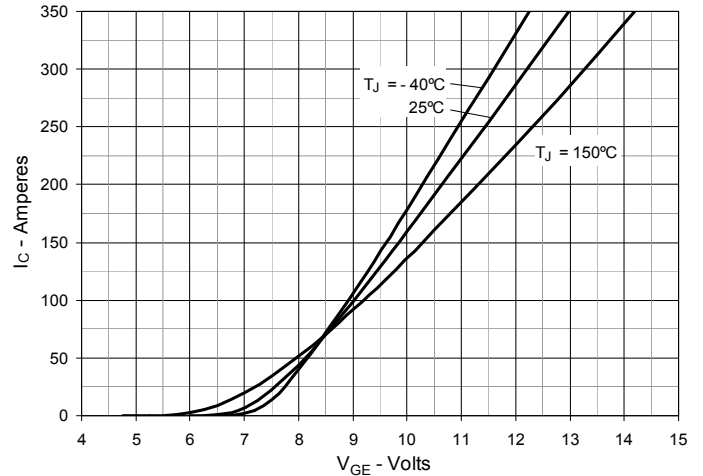

Fig. 7. Transconductance

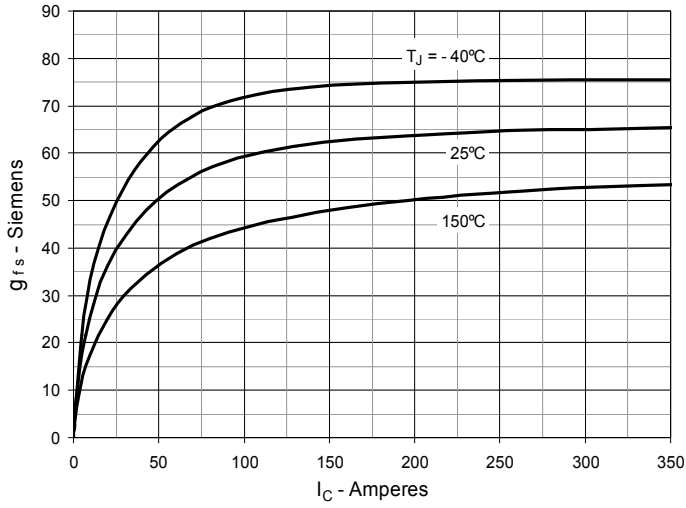

Fig. 8. Gate Charge

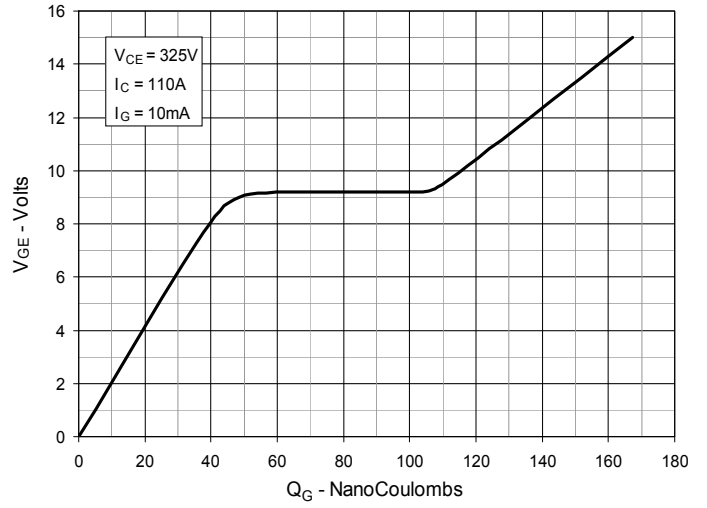

Fig. 9. Capacitance

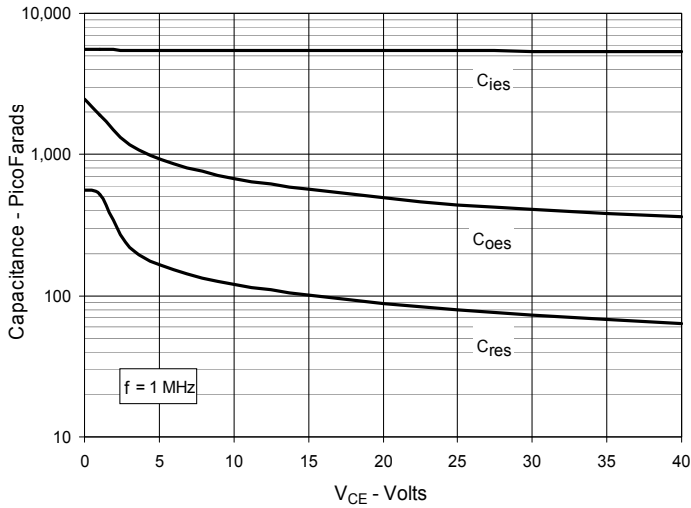

Fig. 10. Reverse-Bias Safe Operating Area

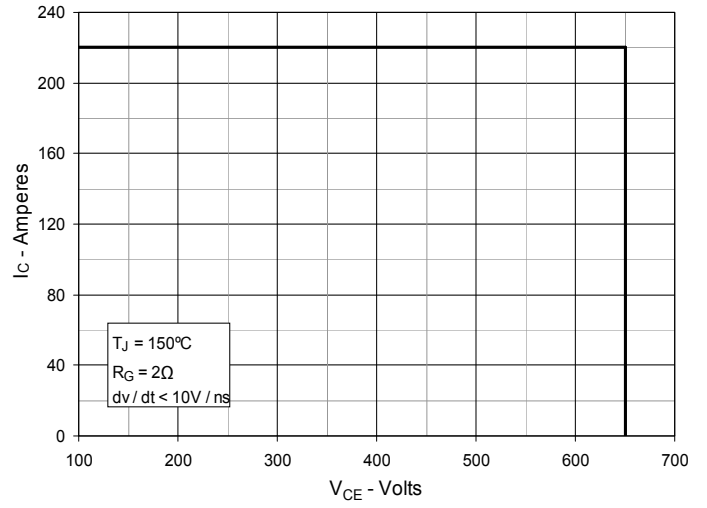

Fig. 11. Maximum Transient thermal Impedance (IGBT)

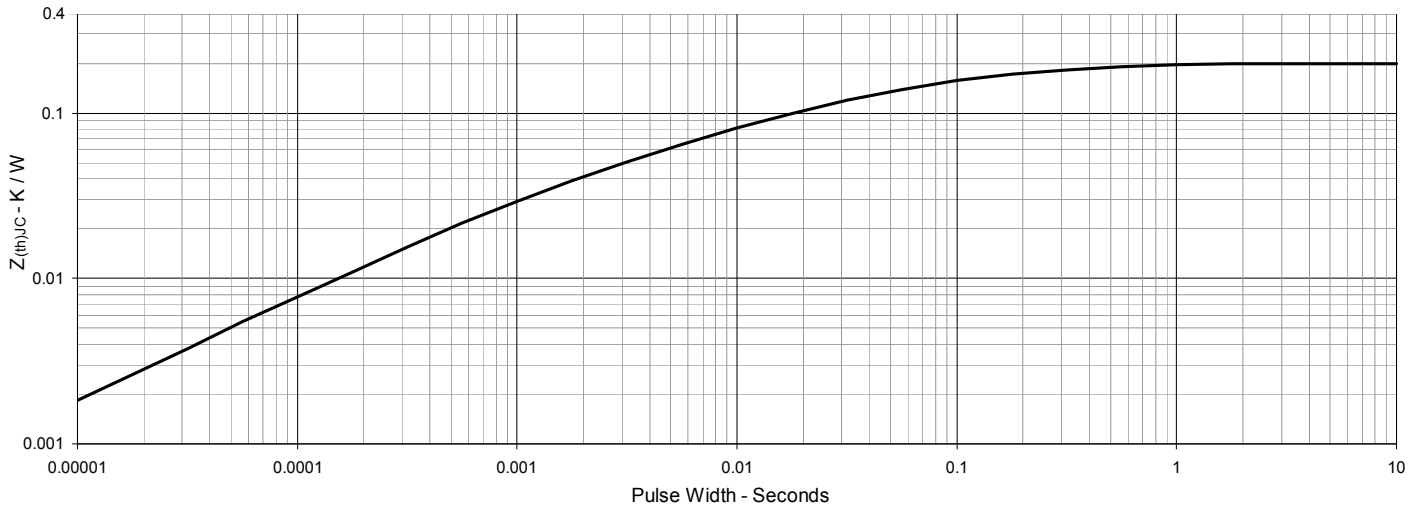

Fig. 12. Inductive Switching Energy Loss vs. Gate Resistance

Fig. 13. Inductive Switching Energy Loss vs. Collector Current

Fig. 14. Inductive Switching Energy Loss vs. Junction Temperature

Fig. 15. Inductive Turn-off Switching Times vs. Gate Resistance

Fig. 16. Inductive Turn-off Switching Times vs. Collector Current

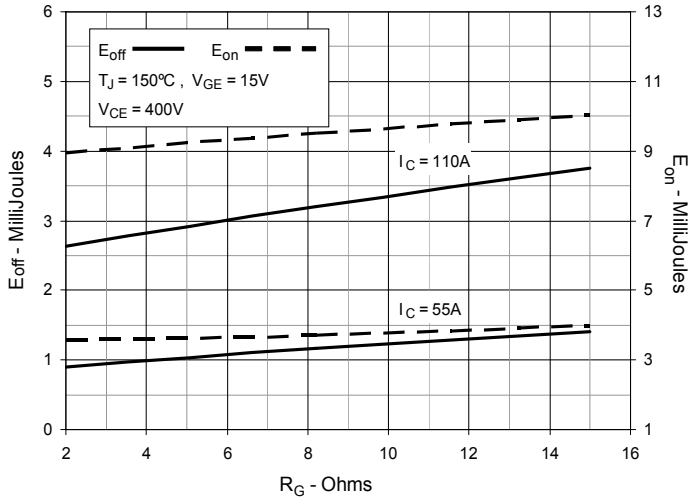
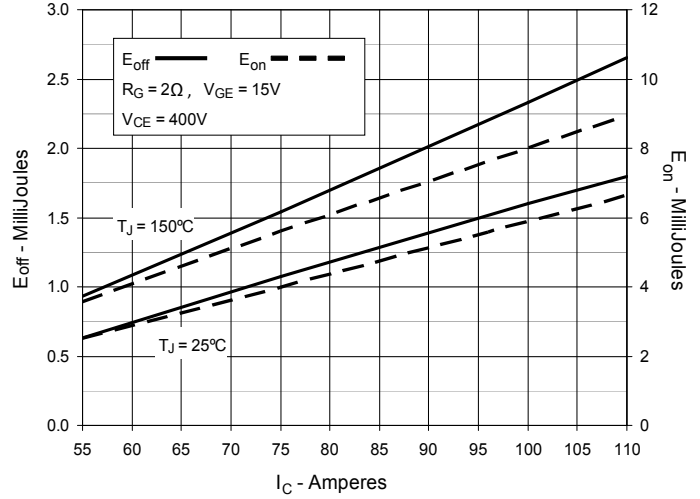
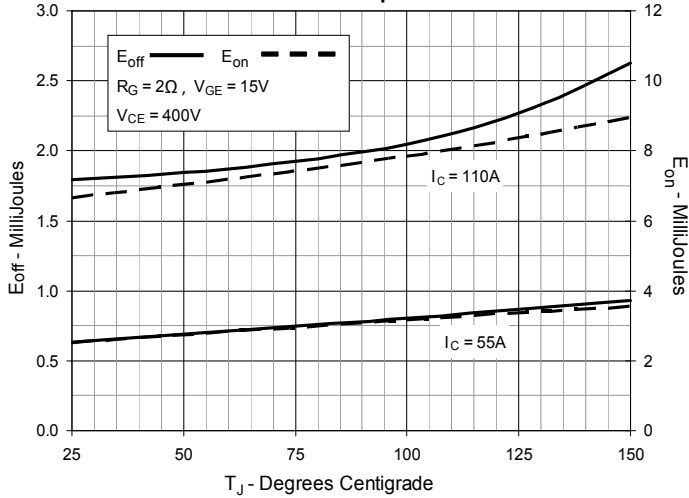
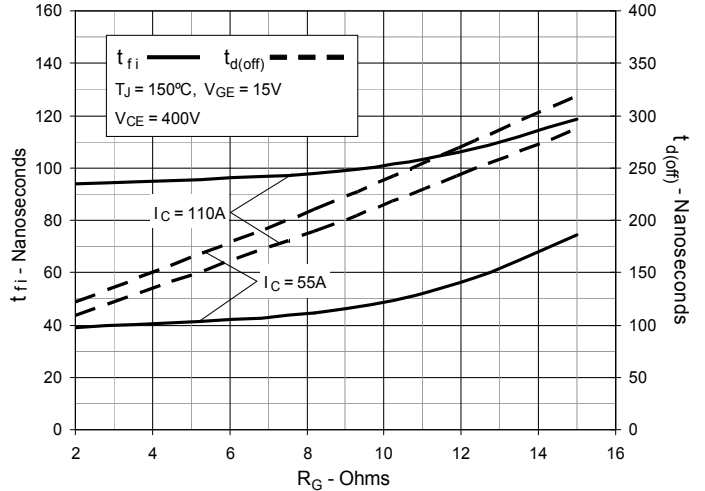
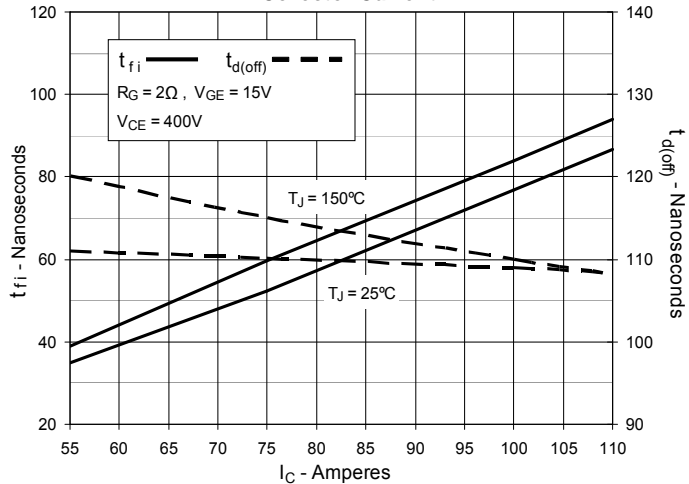
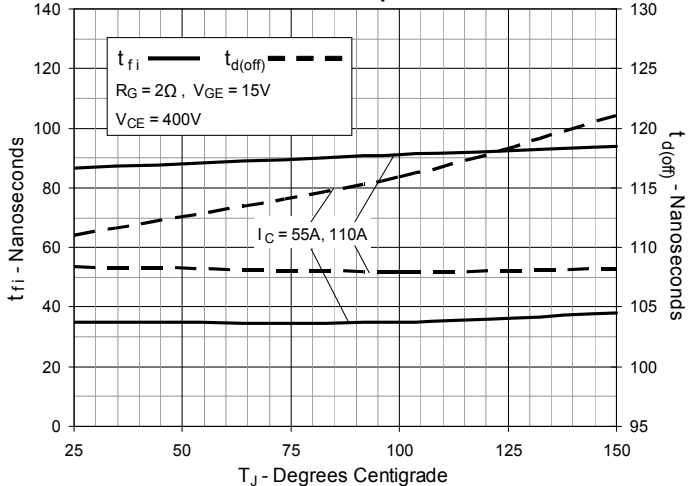
Fig. 17. Inductive Turn-off Switching Times vs. Junction Temperature

Fig. 18. Inductive Turn-on Switching Times vs. Gate Resistance

Fig. 19. Inductive Turn-on Switching Times vs. Collector Current

Fig. 20. Inductive Turn-on Switching Times vs. Junction Temperature

Fig. 21. Typ. Forward characteristics

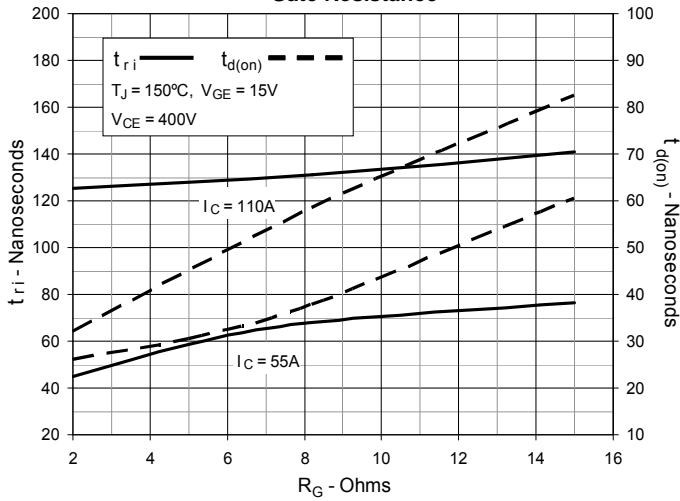
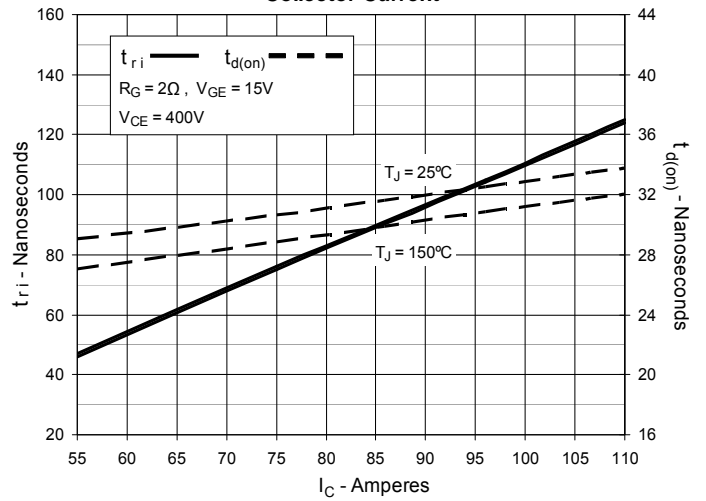
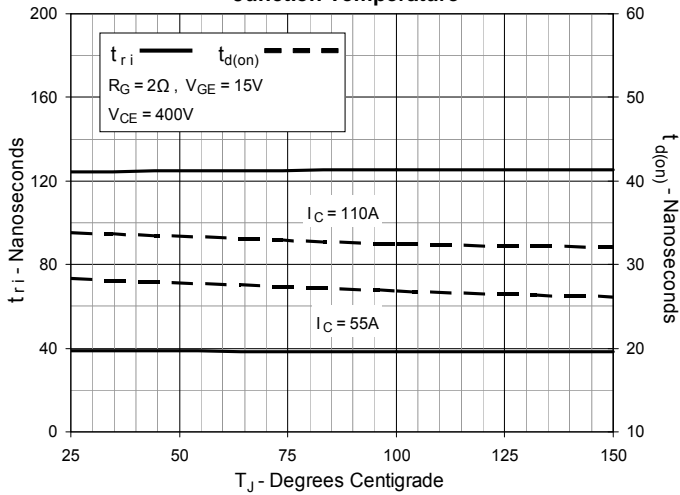
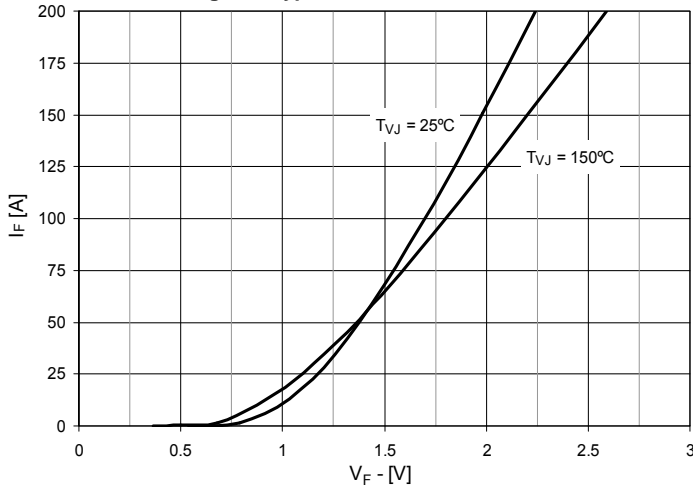

Fig. 22. Typ. Reverse Recovery Charge Q_{rr} vs. $-di_F/dt$

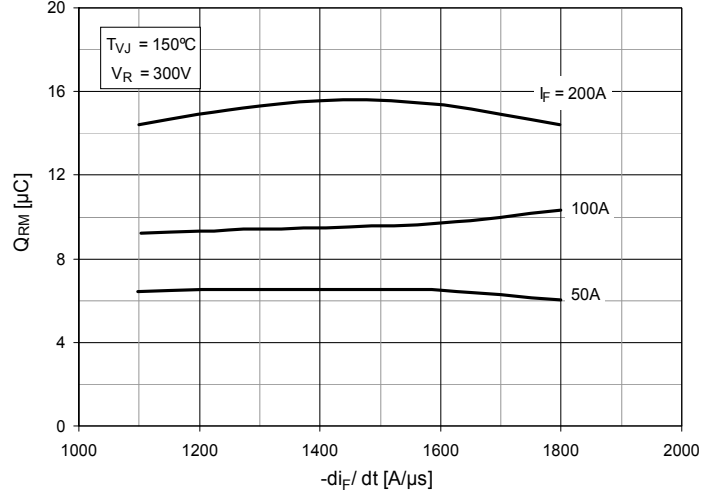

Fig. 23. Typ. Peak Reverse Current I_{RM} vs. $-di_F/dt$

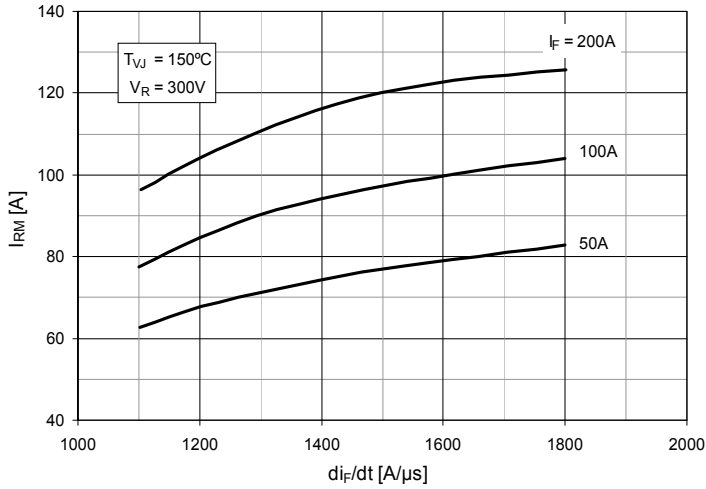

Fig. 24. Typ. Recovery Time t_{rr} vs. $-di_F/dt$

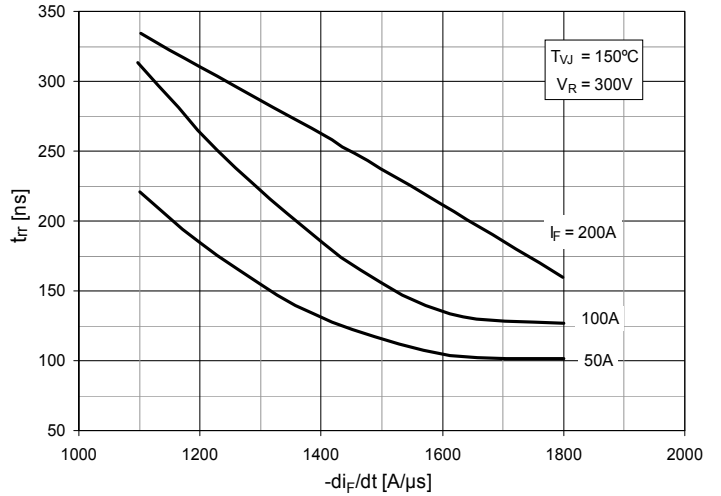

Fig. 25. Typ. Recovery Energy E_{rec} vs. $-di_F/dt$

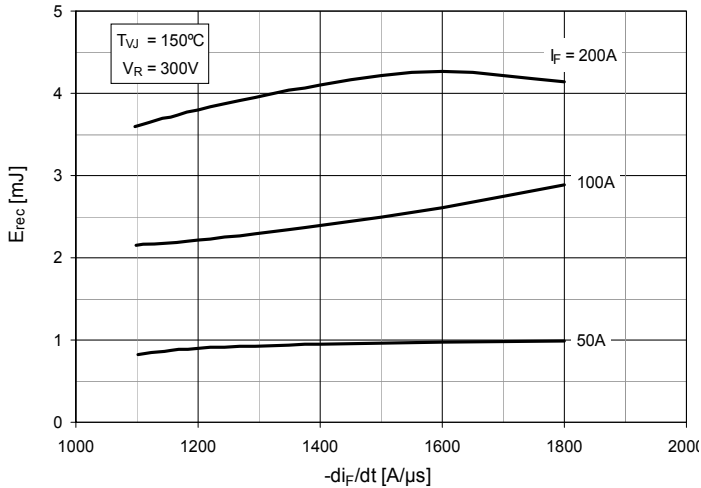
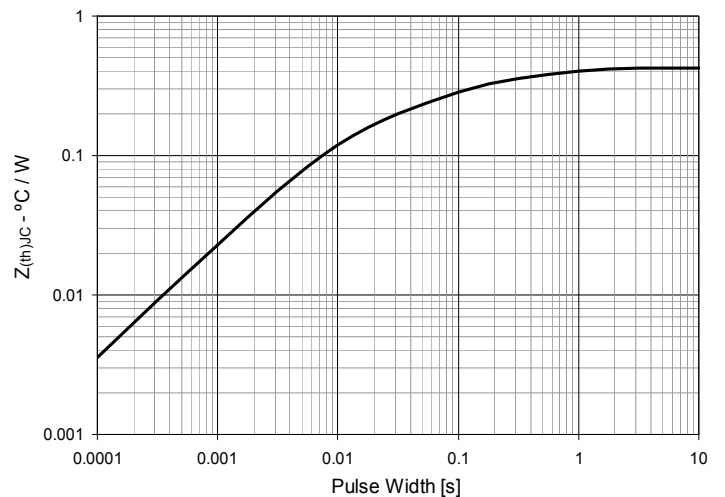

Fig. 26. Maximum Transient Thermal Impedance (Diode)





Disclaimer Notice - Information furnished is believed to be accurate and reliable. However, users should independently evaluate the suitability of and test each product selected for their own applications. Littelfuse products are not designed for, and may not be used in, all applications. Read complete Disclaimer Notice at www.littelfuse.com/disclaimer-electronics.

Forward-Biased, Reverse-Biased, and Short-Circuit Safe Operating Area of MOSFETs and IGBTs



Objectives

This document explains the operating conditions that a power semiconductor is supposed to work in without being damaged. Focus is set on the *Forward-Biased Safe Operating Area (FBSOA)*, the *Reverse Biased, Safe Operating Area (RBSOA)* and the *Short-Circuit Safe Operating Area (SCSOA)*.

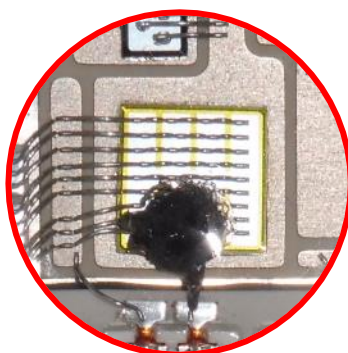

Figure 1. To be prevented – an IGBT destroyed by RBSOA-exceedance

Applications

The information compiled in this document is relevant for the power semiconductor itself and thus for all its applications.

Target Audience

This document is intended for all developers, design- and test-engineers involved in building power semiconductor applications.

Contact Information

For more information on the topic of safely operating power devices, contact the Littelfuse Power Semiconductor team of product and applications experts:

- PowerSemiSupport@Littelfuse.com

Table of Contents

1. Safe Operating Area (SOA), also called Forward-Bias Safe Operating Area (FBSOA).....	4
2. Reverse Biased Safe Operating Area (RBSOA)	5
3. Short-Circuit Safe Operating Area (SCSOA).....	6
4. Resulting challenges for the designer	6
5. Conclusion.....	8

List of Figures

Figure 1. To be prevented – an IGBT destroyed by RBSOA-exceedance	1
Figure 2. SOA Diagram for the IXTX46N50L	4
Figure 3. Voltage and current waveforms during a turn-off event	5
Figure 4. RBSOA-shape, limited by maximum current and breakdown voltage	5
Figure 5. SCSOA information taken from the MDMA280UB1600PTED datasheet.....	6
Figure 6. RBSOA, SCSOA, and the undefined region in between.....	6
Figure 7. Measurement results from a destructive turn-off event.....	7
Figure 8. Locating the point of turn-off	7
Figure 9. Properly turned off overcurrent or short-circuit event.....	8

Introduction

Power semiconductors like IGBTs, GTOs, thyristors, diodes, or bipolar junction transistors (BJT) have been developed into robust and reliable devices which can by now handle power levels into the MW-range and even beyond.

Despite these developments, they all have physical limitations which need to be known and respected to prevent damage to these components and the system they are mounted in. Depending on the instantaneous mode of operation, different conditions are described by a varying set of parameters, often referred to as operating area.

1. Safe Operating Area (SOA), also called Forward-Bias Safe Operating Area (FBSOA)

When a power semiconductor like an IGBT is used to conduct current in the predestined direction, the physical limits of the device to be considered include:

- the maximum collector current I_C ,
- the saturation voltage V_{CEsat} across the device,
- the power generated by the product $I_C \cdot V_{CEsat}$, and
- the maximum junction temperature T_{VJ} allowed.

In cases where the power semiconductor is a MOSFET, dedicated to be operated in linear mode, the current can be influenced by tuning the gate-source-voltage accordingly. As a consequence, the drain-source-voltage V_{DS} of the devices changes which in turn impacts the losses. The device must dissipate these losses and the thermal impedance of the device poses the limits here.

For these operating conditions, the FBSOA-diagram features the forward voltage, the current and limits imposed by thermal development. Looking at Figure 2, it becomes obvious that growing losses can only be tolerated for shorter periods of time.

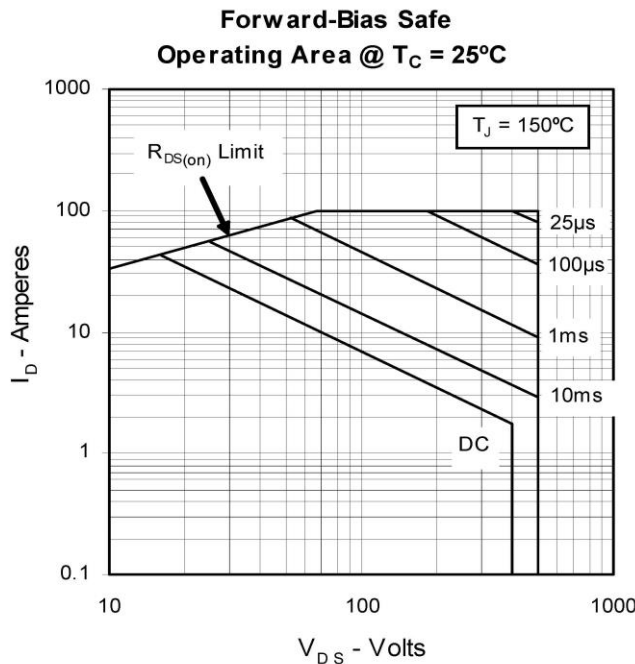

Figure 2. SOA Diagram for the IXTX46N50L

Any combination of forward voltage and current that is found below the correlating lines within the diagram is a legal point of operation as long as the junction temperature remains below the maximum limit and the duration of the loading is properly chosen. De-rating must be considered if the case temperature is different from the 25°C the diagram in Figure 2 refers to.

2. Reverse Biased Safe Operating Area (RBSOA)

Power semiconductors like IGBTs or MOSFETs can turn off a current rather quickly but not at infinite speed. As the switching procedure does take some time, transient phenomena happen that need to be considered.

During this short period, when the device turns from conducting into blocking mode, the Reverse Biased Safe Operating Area needs to be respected at any time.

The limits are given by the current which is turned off and the voltage that appears across the device. The plot in Figure 3 schematically displays a turn-off event in detail.

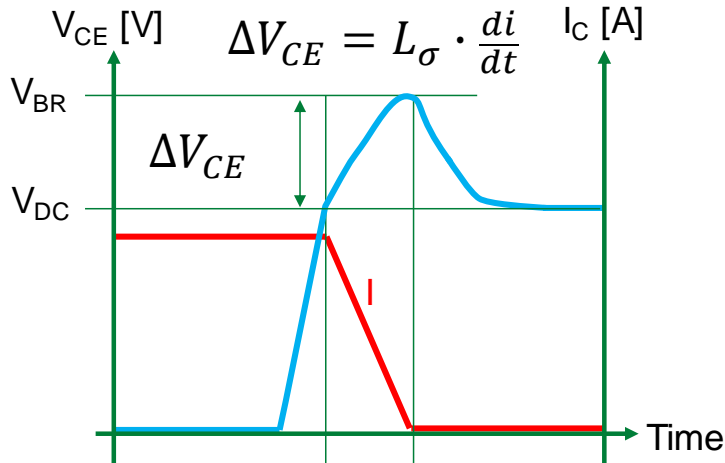

Figure 3. Voltage and current waveforms during a turn-off event

In the graph, it can clearly be seen that the voltage across the device first reaches the DC-link’s voltage level before the current starts declining. Because of the current change rate di/dt and the inherently contained stray inductances L_σ , the voltage spike ΔV_{CE} is added on top of the DC-link voltage. If this spike exceeds the device’s breakdown voltage V_{BR} – even for a very short period of time – the device will be destroyed.

The square-shaped Reverse Biased Safe Operating Area therefore is given by maximum current $I_{C,max}$ and the breakdown voltage V_{BR} , as depicted in Figure 4. Here too, the junction temperature poses a further limit.

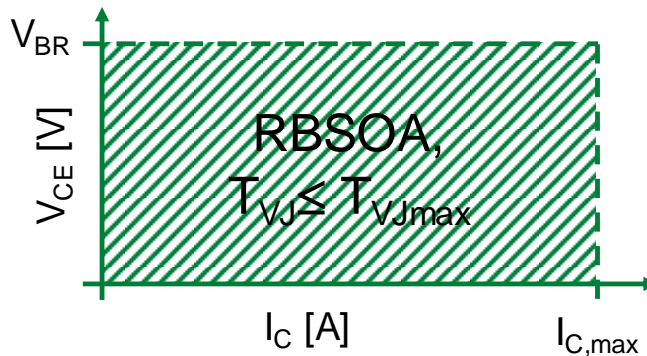

Figure 4. RBSOA-shape, limited by maximum current and breakdown voltage

3. Short-Circuit Safe Operating Area (SCSOA)

Devices that feature desaturation, like most IGBTs, can withstand short-circuit events for a distinct duration. Corresponding datasheets highlight this information as Short Circuit Safe Operating Area or SCSOA. Such a datasheet’s excerpt is given in Figure 5.

SCSOA	<i>short circuit safe operating area</i>	$V_{CEK} = 1200\text{ V}$				
t_{sc}	<i>short circuit duration</i>	$V_{CE} = 720\text{ V}; V_{GE} = \pm 15$	$T_{VJ} = 125^\circ\text{C}$		10	μs
I_{sc}	<i>short circuit current</i>	$R_G = 6.8\Omega$; non-repetitive		450		A

Figure 5. SCSOA information taken from the MDMA280UB1600PTED datasheet

The short circuit condition demands that the IGBT goes into desaturation. In this mode, no further charge carriers remain available which also limits the current. Typically, IGBTs limit the short-circuit current to about three to four times their rated current. In the example in Figure 5, the 160 A-device is expected to limit the short circuit current to 450 A. This situation is tolerable for 10 μs only and limited by thermal development.

4. Resulting challenges for the designer

Combining the two areas for Reverse Biased Safe Operation and Short Circuit Safe Operation into a single diagram reveals a gap between them, as pictured in Figure 6.

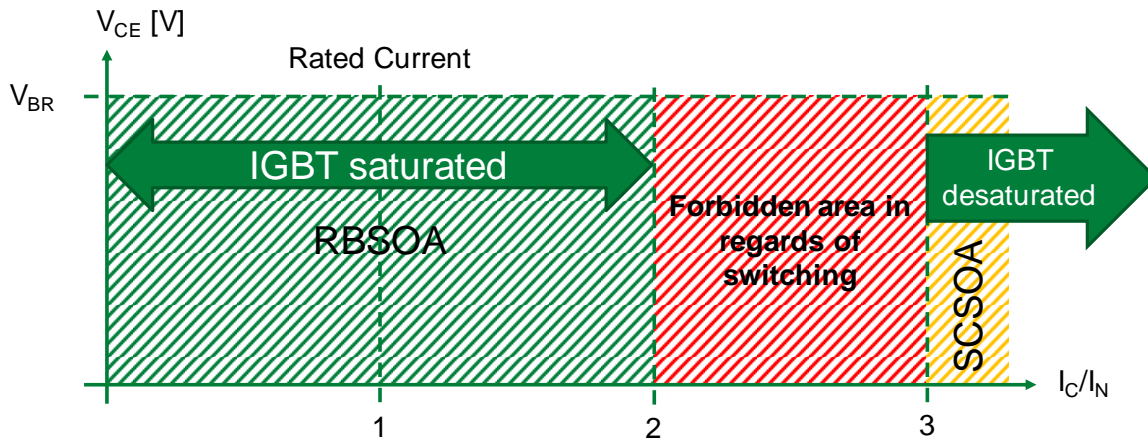

Figure 6. RBSOA, SCSOA, and the undefined region in between

Within the gap marked as forbidden area, located between twice and three times rated current, turning off the device is not allowed as it may lead to its destruction. The root cause of the destruction is found in very high local current densities, transiently forming during switching. The thermal limits in that case are reached already and additional burden due to switching losses leads to exceeding the limits. In turn, single cells on the chip fail and create a connection between collector and emitter. The current can no longer be turned off and the damage grows.

To overcome this situation, techniques to ensure that the IGBT reaches desaturation mode and enters the SCSOA can be used. The simplest way is to wait, instead of reacting on an overcurrent too quickly. Implementing a certain dead-time and fully exploit the 10 μs that the IGBT can withstand the conditions is a valid approach.

Further methods include the so-called 2-Level turn-off. The device is not turned off by immediately cancelling or even reversing the gate-emitter voltage. Instead, the gate-emitter voltage is first reduced to minimize the number of charge carriers available for current transport. This speeds up reaching the desaturation stage. A few microseconds later, when desaturation is reached, the gate-emitter voltage is set to zero or reversed. The device is then safely turned off within the SCSOA-specification.

This fact becomes particularly important when handling overcurrent situations.

From a given setup, measurements from a destructive turn-off event seen in Figure 7 were analyzed:

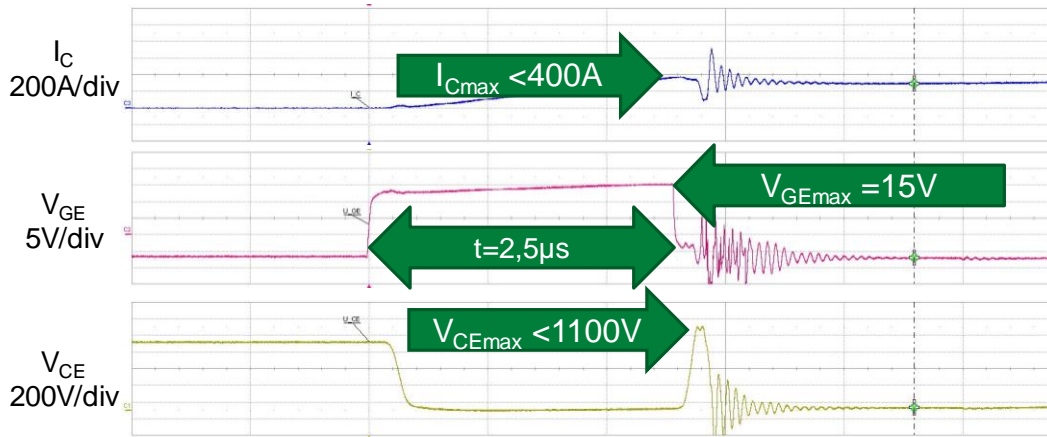

Figure 7. Measurement results from a destructive turn-off event

As the measurement reveals, the current turned off was well below the 450 A short-circuit limit. The gate-emitter-voltage was well-controlled, the time it took to turn off was below the 10 µs-limit and the overvoltage spike did not exceed the 1200 V the device is rated for. Still, the IGBT was destroyed, and the question raised, why so?

Entering the point of the turn-off into the diagram in Figure 6, the violation that happens becomes obvious in Figure 8:

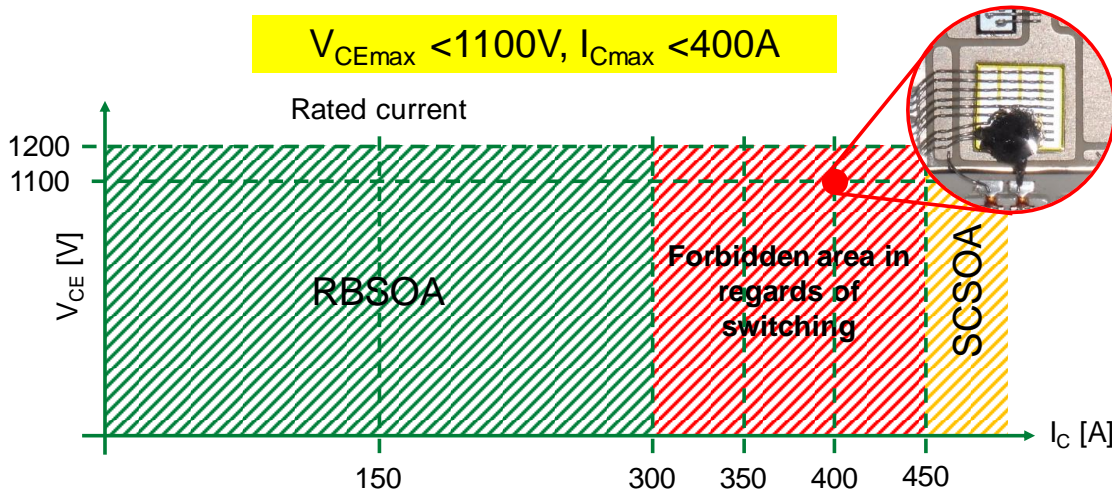

Figure 8. Locating the point of turn-off

Clearly, the switching event was done within the no-go-area with the destructive effect previously predicted.

To clear the situation, the control strategy for short circuit was changed. Instead of reacting on the overcurrent signal instantly and turn off after just 2.5 μs , a blanking time of about 6 μs was added.

Figure 9 represents the measurement done in the same setup.

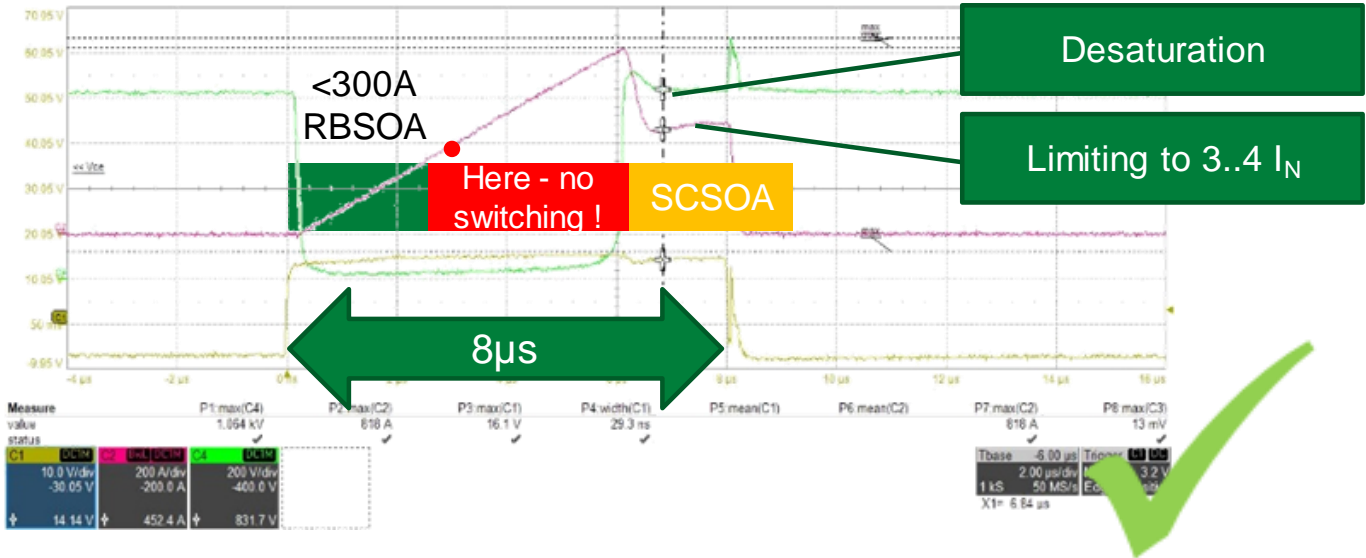

Figure 9. Properly turned off overcurrent or short-circuit event

While the red dot marks the former turn-off point, the current is now allowed to grow further. At first sight, this seems to worsen the situation as the losses and, as such, the chip temperature grows. However, after about 6 μs the IGBT reaches desaturation, enters the SCSOA and the turn-off after 8 μs is safely done without damaging the component.

MOSFETs, other than IGBTs, don't feature a dedicated SCSOA. At high currents, the MOSFET goes into linear operation as depicted in the FBSOA-diagram, so short-circuit and overcurrent events are covered by diagrams as given in Figure 2.

5. Conclusion

Handling overcurrent events, especially short circuit events, is challenging but manageable. Doing so while remaining within the given specifications can successfully be achieved.

Simply turning off a detected overcurrent as fast as possible may not be the best strategy as it may lead to damage caused by so-called RBSOA-exceedance. Ensuring that the IGBT reaches desaturation is a key factor in handling short circuit events with this technology.

For additional information please visit www.Littelfuse.com/powersemi

Disclaimer Notice - This document is provided by Littelfuse, Inc. ("Littelfuse") for informational and guideline purposes only. Littelfuse assumes no liability for errors or omissions in this document or for any of the information contained herein. Information is provided on an "as is" and "with all faults" basis for evaluation purposes only. Applications described are for illustrative purposes only and Littelfuse makes no representation that such applications will be suitable for the customer's specific use without further testing or modification. Littelfuse expressly disclaims all warranties, whether express, implied or statutory, including but not limited to the implied warranties of merchantability and fitness for a particular purpose, and non-infringement. It is the customer's sole responsibility to determine suitability for a particular system or use based on their own performance criteria, conditions, specific application, compatibility with other components, and environmental conditions. Customers must independently provide appropriate design and operating safeguards to minimize any risks associated with their applications and products.

Littelfuse products are not designed for, and shall not be used for, any purpose (including, without limitation, automotive, military, aerospace, medical, life-saving, life-sustaining or nuclear facility applications, devices intended for surgical implant into the body, or any other application in which the failure or lack of desired operation of the product may result in personal injury, death, or property damage) other than those expressly forth in applicable Littelfuse product documentation. Littelfuse shall not be liable for any claims or damages arising out of products used in applications not expressly intended by Littelfuse as set forth in applicable Littelfuse documentation.

Read complete Disclaimer Notice at www.littelfuse.com/disclaimer-electronics