

**XPT™ 650V IGBT**  
**GenX4™**
**IXXK200N65B4**  
**IXXX200N65B4**

$$V_{CES} = 650V$$

$$I_{C110} = 200A$$

$$V_{CE(sat)} \leq 1.7V$$

$$t_{fi(typ)} = 80ns$$

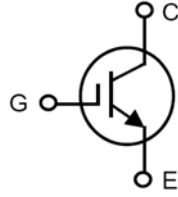
 Extreme Light Punch Through  
 IGBT for 10-30kHz Switching

Symbol	Test Conditions	Maximum Ratings	
$V_{CES}$	$T_J = 25^\circ C$ to $175^\circ C$	650	V
$V_{CGR}$	$T_J = 25^\circ C$ to $175^\circ C$ , $R_{GE} = 1M\Omega$	650	V
$V_{GES}$	Continuous	$\pm 20$	V
$V_{GEM}$	Transient	$\pm 30$	V
$I_{C25}$	$T_C = 25^\circ C$ (Chip Capability)	480	A
$I_{LRMS}$	Lead Current Limit	160	A
$I_{C110}$	$T_C = 110^\circ C$	200	A
$I_{CM}$	$T_C = 25^\circ C$ , 1ms	1100	A
<b>SSOA</b>	$V_{GE} = 15V$ , $T_{VJ} = 150^\circ C$ , $R_G = 1\Omega$	$I_{CM} = 400$	A
<b>(RBSOA)</b>	Clamped Inductive Load	@ $V_{CE} \leq V_{CES}$	
$t_{sc}$	$V_{GE} = 15V$ , $V_{CE} = 360V$ , $T_J = 150^\circ C$	10	$\mu s$
<b>(SCSOA)</b>	$R_G = 10\Omega$ , Non Repetitive		
$P_C$	$T_C = 25^\circ C$	1630	W
$T_J$		-55 ... +175	$^\circ C$
$T_{JM}$		175	$^\circ C$
$T_{stg}$		-55 ... +175	$^\circ C$
$T_L$	Maximum Lead Temperature for Soldering	300	$^\circ C$
$T_{SOLD}$	1.6 mm (0.062in.) from Case for 10s	260	$^\circ C$
$M_d$	Mounting Torque (TO-264)	1.13/10	Nm/lb.in
$F_C$	Mounting Force (PLUS247)	20..120 /4.5..27	N/lb
<b>Weight</b>	TO-264	10	g
	PLUS247	6	g

TO-264 (IXXK)

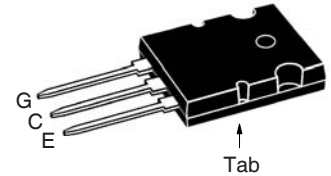

PLUS247 (IXXX)

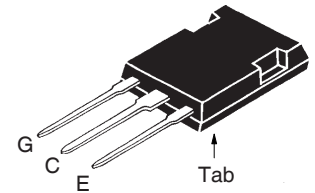

G = Gate                      E = Emitter  
 C = Collector                Tab = Collector

**Features**

- Optimized for 10-30kHz Switching
- Square RBSOA
- Short Circuit Capability
- International Standard Packages
- High Current Handling Capability

**Advantages**

- High Power Density
- Low Gate Drive Requirement

**Applications**

- Power Inverters
- UPS
- Motor Drives
- SMPS
- PFC Circuits
- Battery Chargers
- Welding Machines
- Lamp Ballasts

Symbol	Test Conditions ( $T_J = 25^\circ C$ , Unless Otherwise Specified)	Characteristic Values		
		Min.	Typ.	Max.
$BV_{CES}$	$I_C = 250\mu A$ , $V_{GE} = 0V$	650		V
$V_{GE(th)}$	$I_C = 4mA$ , $V_{CE} = V_{GE}$	4.0		6.5 V
$I_{CES}$	$V_{CE} = V_{CES}$ , $V_{GE} = 0V$ $T_J = 150^\circ C$			25 $\mu A$ 2 mA
$I_{GES}$	$V_{CE} = 0V$ , $V_{GE} = \pm 20V$			$\pm 200$ nA
$V_{CE(sat)}$	$I_C = 160A$ , $V_{GE} = 15V$ , Note 1 $T_J = 150^\circ C$		1.4 1.6	1.7 V V

Symbol Test Conditions ( $T_J = 25^\circ\text{C}$ Unless Otherwise Specified)		Characteristic Values		
		Min.	Typ.	Max.
$g_{fs}$	$I_C = 60\text{A}, V_{CE} = 10\text{V}$ , Note 1	54	90	S
$C_{ies}$	$V_{CE} = 25\text{V}, V_{GE} = 0\text{V}, f = 1\text{MHz}$		11.25	nF
$C_{oes}$			670	pF
$C_{res}$			390	pF
$Q_{g(on)}$	$I_C = 200\text{A}, V_{GE} = 15\text{V}, V_{CE} = 0.5 \cdot V_{CES}$		553	nC
$Q_{ge}$			110	nC
$Q_{gc}$			253	nC
$t_{d(on)}$	<b>Inductive load, <math>T_J = 25^\circ\text{C}</math></b> $I_C = 100\text{A}, V_{GE} = 15\text{V}$ $V_{CE} = 400\text{V}, R_G = 1\Omega$ Note 2		62	ns
$t_{ri}$			76	ns
$E_{on}$			4.40	mJ
$t_{d(off)}$			245	ns
$t_{fi}$			80	ns
$E_{off}$			2.20	3.50 mJ
$t_{d(on)}$	<b>Inductive load, <math>T_J = 150^\circ\text{C}</math></b> $I_C = 100\text{A}, V_{GE} = 15\text{V}$ $V_{CE} = 400\text{V}, R_G = 1\Omega$ Note 2		54	ns
$t_{ri}$			65	ns
$E_{on}$			5.55	mJ
$t_{d(off)}$			236	ns
$t_{fi}$			110	ns
$E_{off}$			2.54	mJ
$R_{thJC}$				$0.092^\circ\text{C/W}$
$R_{thCS}$		0.15		$^\circ\text{C/W}$

**Notes:**

1. Pulse test,  $t \leq 300\mu\text{s}$ , duty cycle,  $d \leq 2\%$ .
2. Switching times & energy losses may increase for higher  $V_{CE}(\text{clamp})$ ,  $T_J$  or  $R_G$ .

**PRELIMINARY TECHNICAL INFORMATION**

The product presented herein is under development. The Technical Specifications offered are derived from a subjective evaluation of the design, based upon prior knowledge and experience, and constitute a "considered reflection" of the anticipated result. IXYS reserves the right to change limits, test conditions, and dimensions without notice.

**TO-264 Outline**

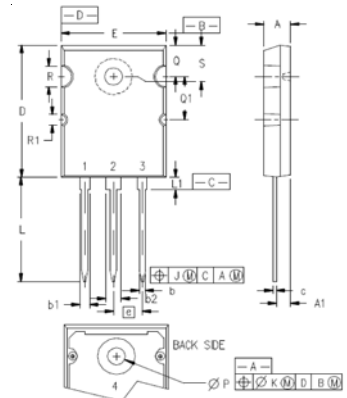

Terminals: 1 = Gate  
2,4 = Collector  
3 = Emitter

SYM	INCHES		MILLIMETERS	
	MIN	MAX	MIN	MAX
A	.185	.209	4.70	5.31
A1	.102	.118	2.59	3.00
b	.037	.055	0.94	1.40
b1	.087	.102	2.21	2.59
b2	.110	.126	2.79	3.20
c	.017	.029	0.43	0.74
D	1.007	1.047	25.58	26.59
E	.760	.799	19.30	20.29
e	.215 BSC		5.46 BSC	
J	.000	.010	0.00	0.25
K	.000	.010	0.00	0.25
L	.779	.842	19.79	21.39
L1	.087	.102	2.21	2.59
ØP	.122	.138	3.10	3.51
Q	.240	.256	6.10	6.50
Q1	.330	.346	8.38	8.79
ØR	.155	.187	3.94	4.75
ØR1	.085	.093	2.16	2.36
S	.243	.253	6.17	6.43

**PLUS247™ Outline**

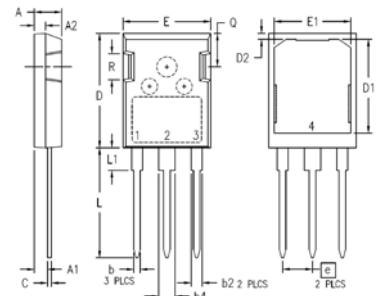

Terminals: 1 - Gate  
2,4 - Collector  
3 - Emitter

SYM	INCHES		MILLIMETERS	
	MIN	MAX	MIN	MAX
A	.190	.205	4.83	5.21
A1	.090	.100	2.29	2.54
A2	.075	.085	1.91	2.16
b	.045	.055	1.14	1.40
b2	.075	.087	1.91	2.20
b4	.115	.126	2.92	3.20
C	.024	.031	0.61	0.80
D	.819	.840	20.80	21.34
D1	.650	.690	16.51	17.53
D2	.035	.050	0.89	1.27
E	.620	.635	15.75	16.13
E1	.520	.560	13.08	14.22
e	.215 BSC		5.45 BSC	
L	.780	.810	19.81	20.57
L1	.150	.170	3.81	4.32
Q	.220	.244	5.59	6.20
R	.170	.190	4.32	4.83

IXYS Reserves the Right to Change Limits, Test Conditions, and Dimensions.

IXYS MOSFETs and IGBTs are covered by one or more of the following U.S. patents:	4,835,592	4,931,844	5,049,961	5,237,481	6,162,665	6,404,065 B1	6,683,344	6,727,585	7,005,734 B2	7,157,338B2
	4,860,072	5,017,508	5,063,307	5,381,025	6,259,123 B1	6,534,343	6,710,405 B2	6,759,692	7,063,975 B2	
	4,881,106	5,034,796	5,187,117	5,486,715	6,306,728 B1	6,583,505	6,710,463	6,771,478 B2	7,071,537	

**Fig. 1. Output Characteristics @  $T_J = 25^\circ\text{C}$**

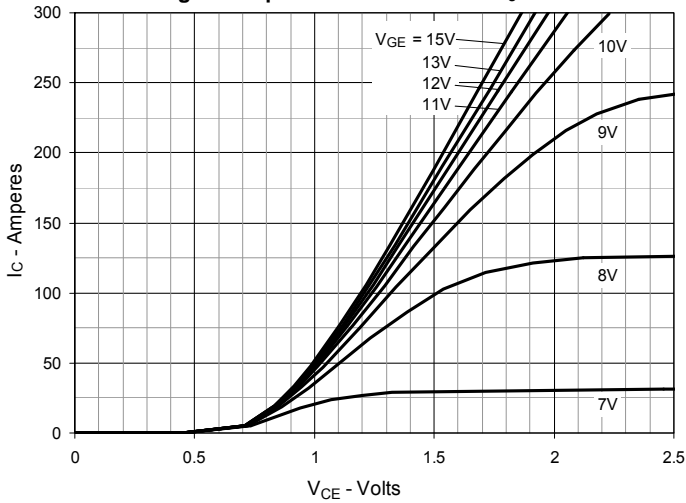

**Fig. 2. Extended Output Characteristics @  $T_J = 25^\circ\text{C}$**

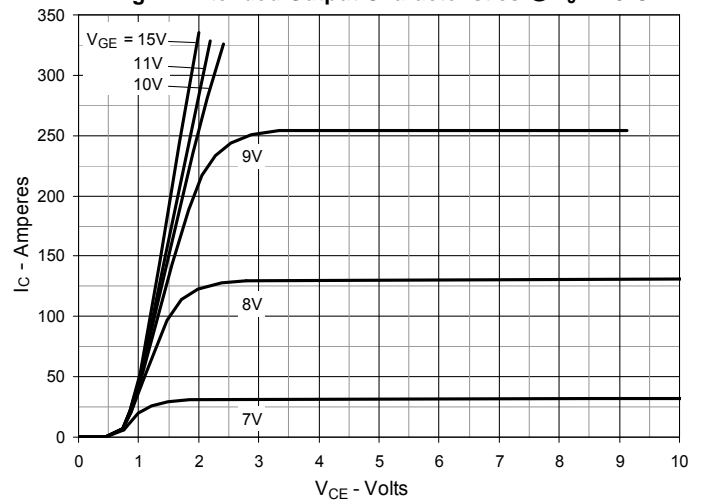

**Fig. 3. Output Characteristics @  $T_J = 150^\circ\text{C}$**

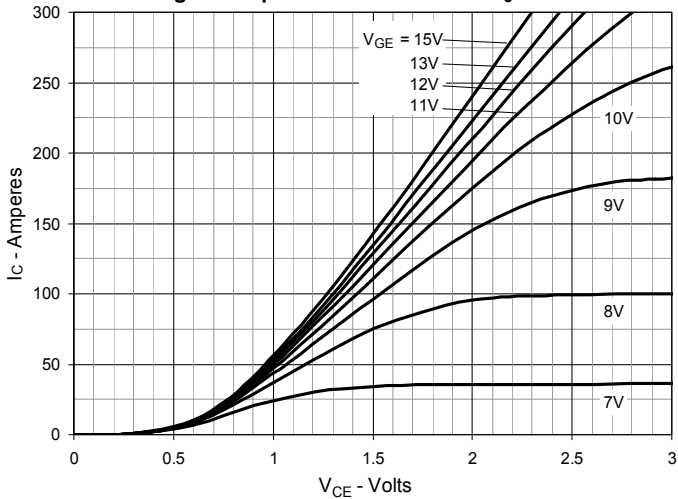

**Fig. 4. Dependence of  $V_{CE(sat)}$  on Junction Temperature**

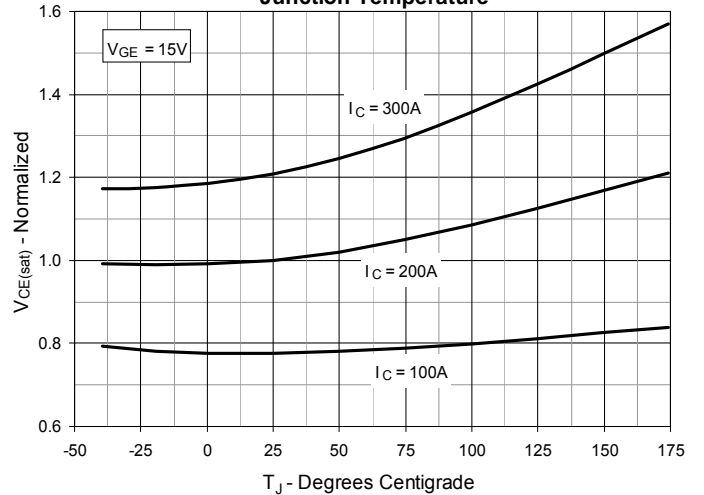

**Fig. 5. Collector-to-Emitter Voltage vs. Gate-to-Emitter Voltage**

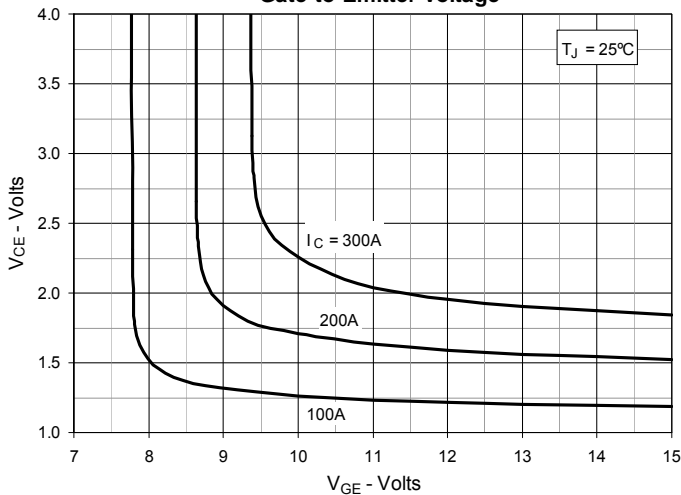

**Fig. 6. Input Admittance**

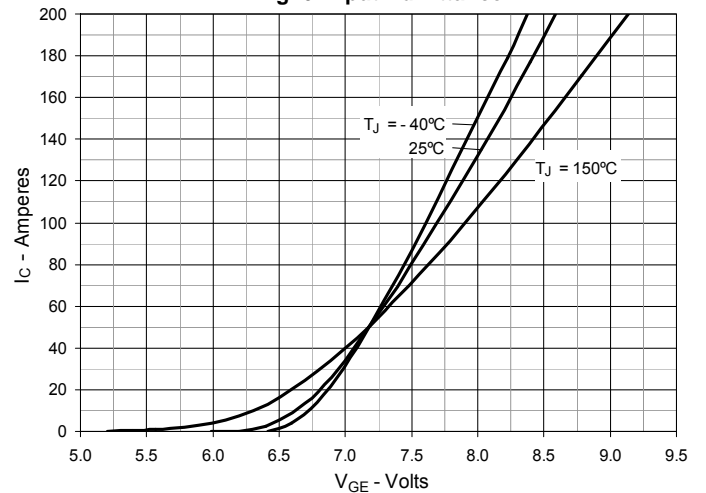

**Fig. 7. Transconductance**

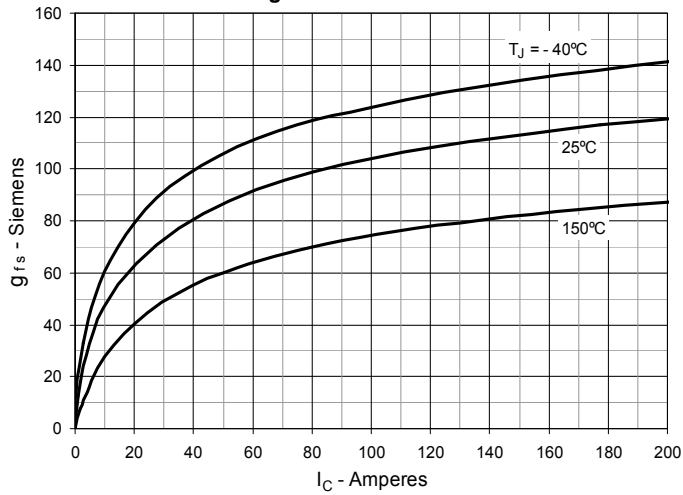

**Fig. 8. Gate Charge**

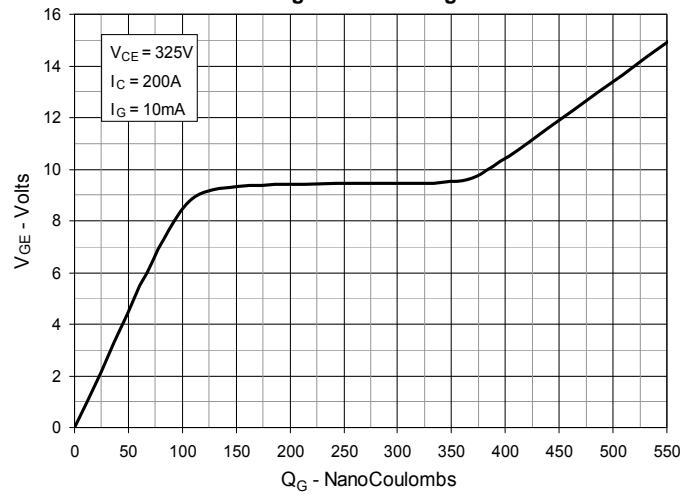

**Fig. 9. Capacitance**

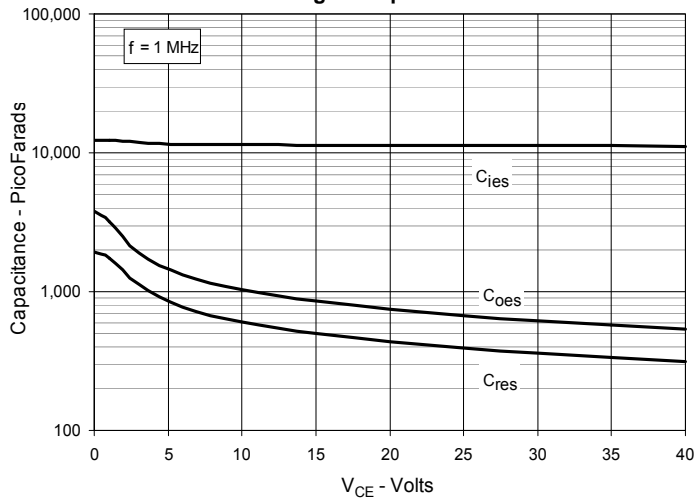

**Fig. 10. Reverse-Bias Safe Operating Area**

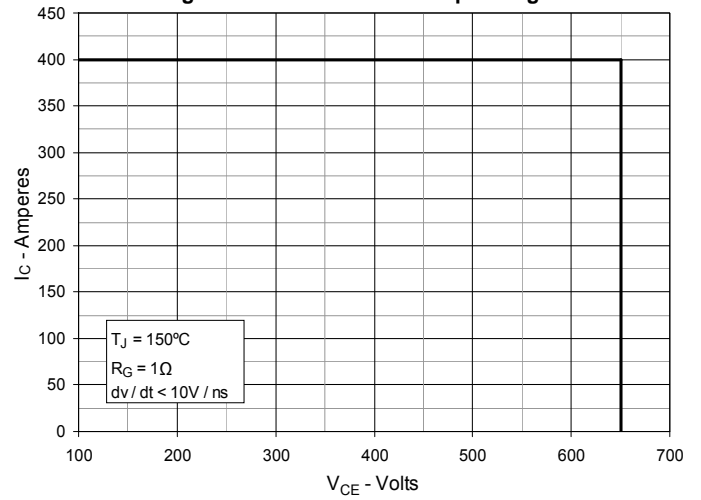

**Fig. 11. Maximum Transient Thermal Impedance**

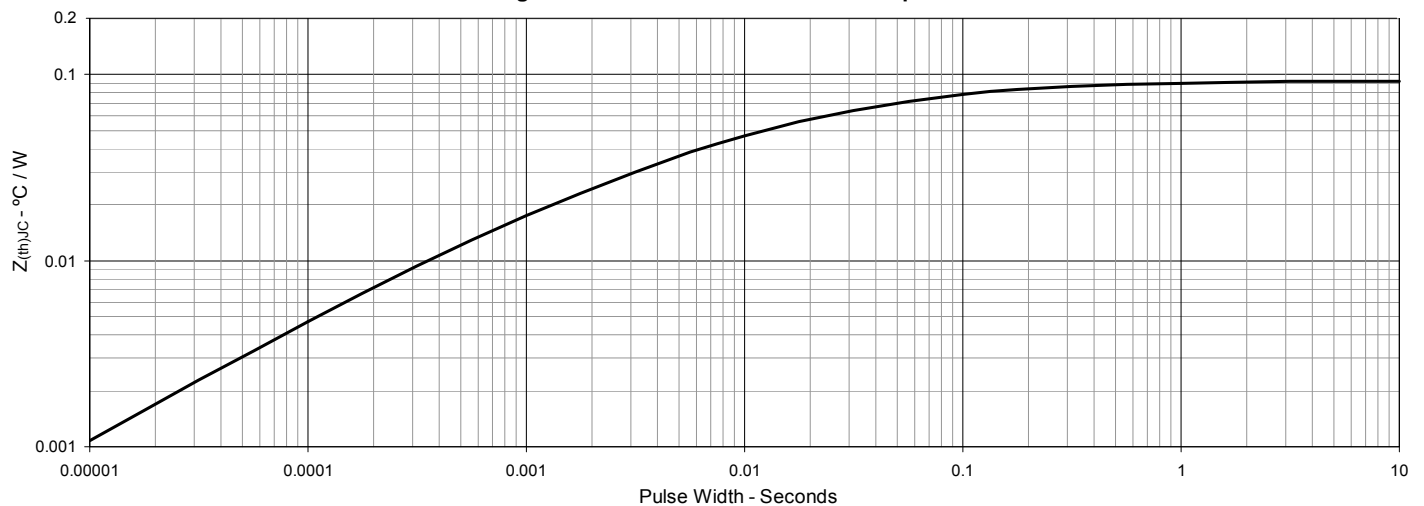

**Fig. 12. Inductive Switching Energy Loss vs. Gate Resistance**

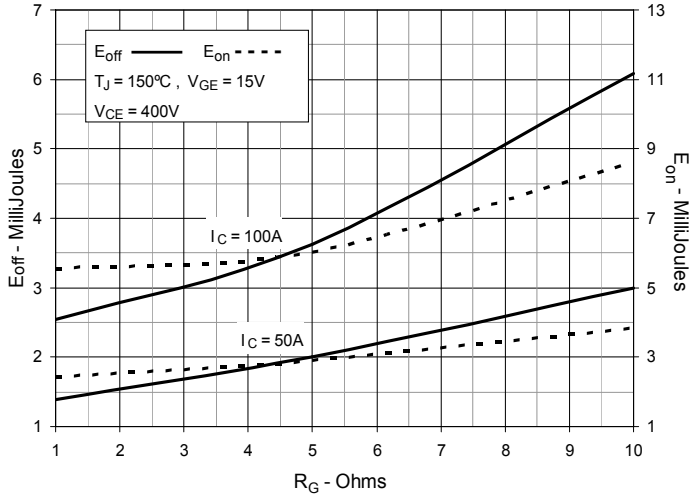

**Fig. 13. Inductive Switching Energy Loss vs. Collector Current**

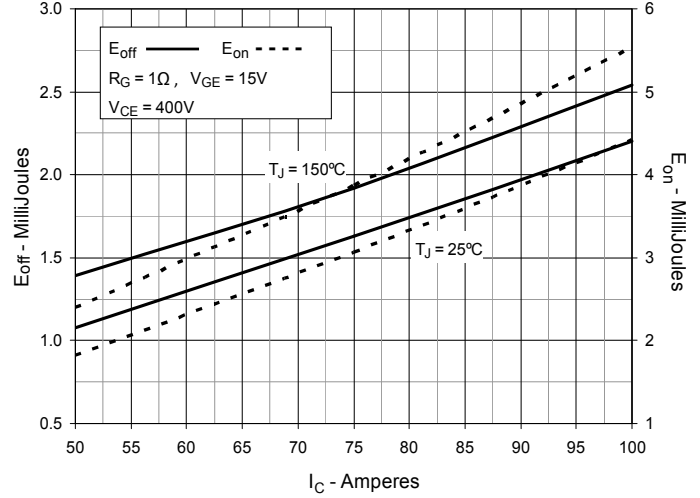

**Fig. 14. Inductive Switching Energy Loss vs. Junction Temperature**

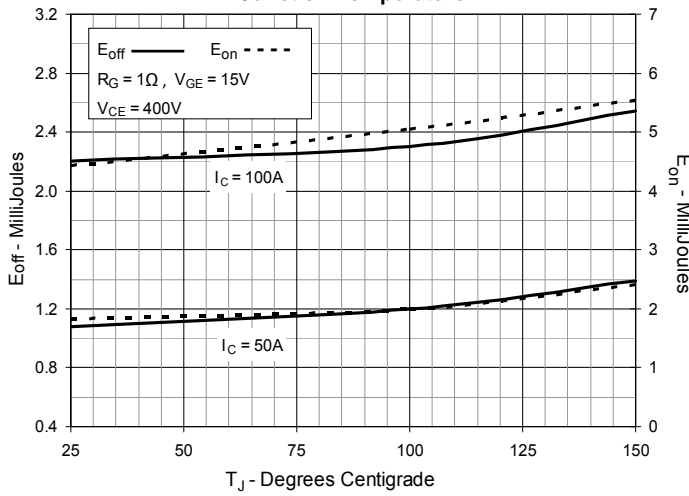

**Fig. 15. Inductive Turn-off Switching Times vs. Gate Resistance**

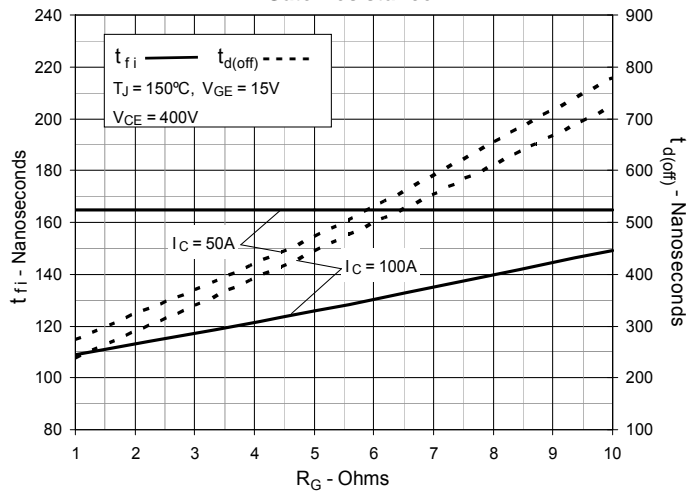

**Fig. 16. Inductive Turn-off Switching Times vs. Collector Current**

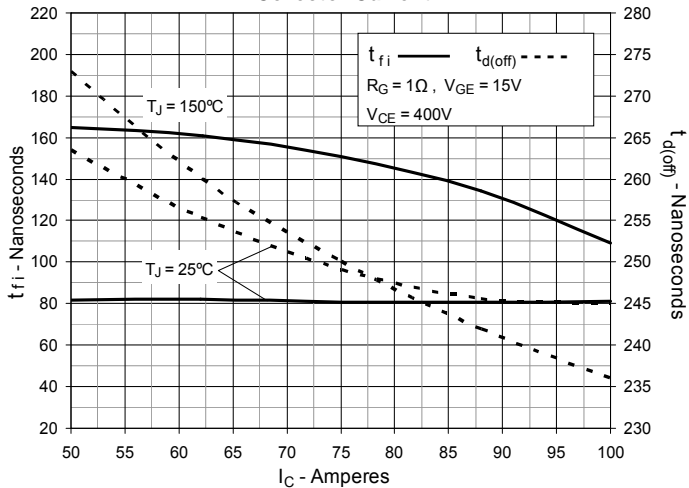

**Fig. 17. Inductive Turn-off Switching Times vs. Junction Temperature**

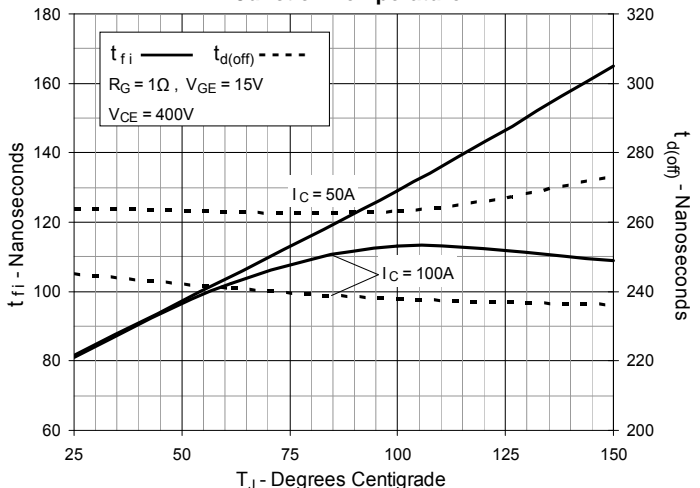

**Fig. 18. Inductive Turn-on Switching Times vs. Gate Resistance**

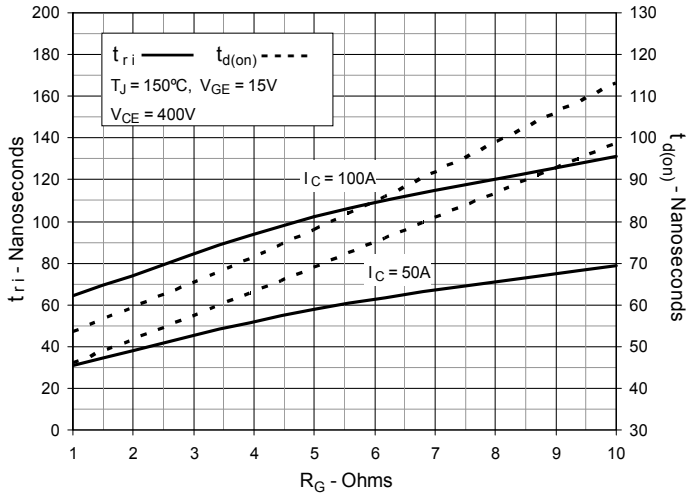

**Fig. 19. Inductive Turn-on Switching Times vs. Collector Current**

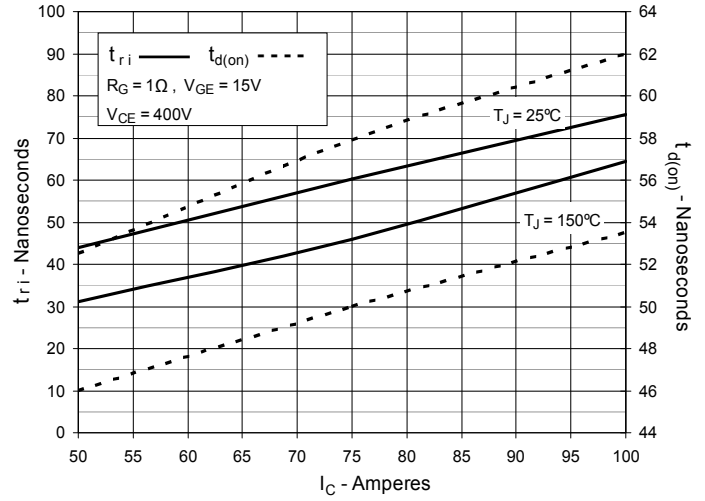

**Fig. 20. Inductive Turn-on Switching Times vs. Junction Temperature**

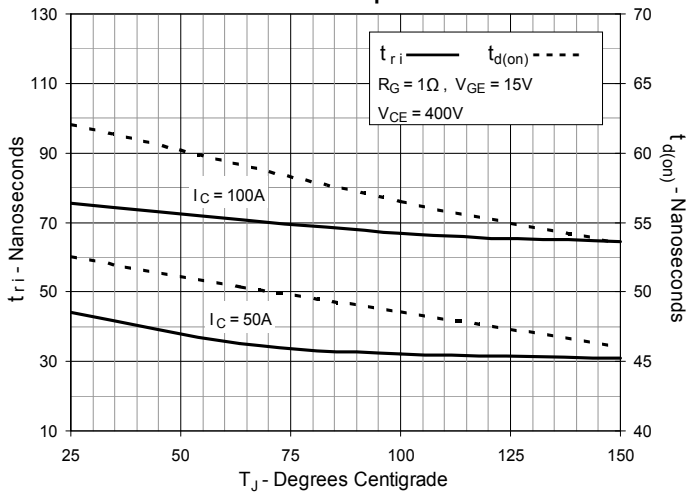



---

Disclaimer Notice - Information furnished is believed to be accurate and reliable. However, users should independently evaluate the suitability of and test each product selected for their own applications. Littelfuse products are not designed for, and may not be used in, all applications. Read complete Disclaimer Notice at [www.littelfuse.com/disclaimer-electronics](http://www.littelfuse.com/disclaimer-electronics).

# Forward-Biased, Reverse-Biased, and Short-Circuit Safe Operating Area of MOSFETs and IGBTs



## Objectives

This document explains the operating conditions that a power semiconductor is supposed to work in without being damaged. Focus is set on the *Forward-Biased Safe Operating Area (FBSOA)*, the *Reverse Biased, Safe Operating Area (RBSOA)* and the *Short-Circuit Safe Operating Area (SCSOA)*.

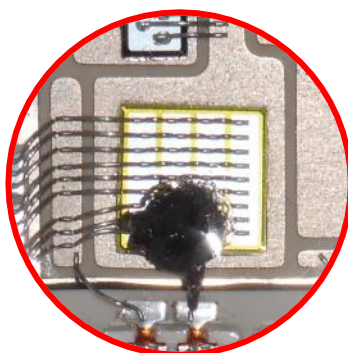

Figure 1. To be prevented – an IGBT destroyed by RBSOA-exceedance

## Applications

The information compiled in this document is relevant for the power semiconductor itself and thus for all its applications.

## Target Audience

This document is intended for all developers, design- and test-engineers involved in building power semiconductor applications.

## Contact Information

For more information on the topic of safely operating power devices, contact the Littelfuse Power Semiconductor team of product and applications experts:

- [PowerSemiSupport@Littelfuse.com](mailto:PowerSemiSupport@Littelfuse.com)

## Table of Contents

1. Safe Operating Area (SOA), also called Forward-Bias Safe Operating Area (FBSOA).....	4
2. Reverse Biased Safe Operating Area (RBSOA) .....	5
3. Short-Circuit Safe Operating Area (SCSOA).....	6
4. Resulting challenges for the designer .....	6
5. Conclusion.....	8

## List of Figures

Figure 1. To be prevented – an IGBT destroyed by RBSOA-exceedance .....	1
Figure 2. SOA Diagram for the IXTX46N50L .....	4
Figure 3. Voltage and current waveforms during a turn-off event .....	5
Figure 4. RBSOA-shape, limited by maximum current and breakdown voltage .....	5
Figure 5. SCSOA information taken from the MDMA280UB1600PTED datasheet.....	6
Figure 6. RBSOA, SCSOA, and the undefined region in between.....	6
Figure 7. Measurement results from a destructive turn-off event.....	7
Figure 8. Locating the point of turn-off .....	7
Figure 9. Properly turned off overcurrent or short-circuit event.....	8

## Introduction

Power semiconductors like IGBTs, GTOs, thyristors, diodes, or bipolar junction transistors (BJT) have been developed into robust and reliable devices which can by now handle power levels into the MW-range and even beyond.

Despite these developments, they all have physical limitations which need to be known and respected to prevent damage to these components and the system they are mounted in. Depending on the instantaneous mode of operation, different conditions are described by a varying set of parameters, often referred to as operating area.

## 1. Safe Operating Area (SOA), also called Forward-Bias Safe Operating Area (FBSOA)

When a power semiconductor like an IGBT is used to conduct current in the predestined direction, the physical limits of the device to be considered include:

- the maximum collector current  $I_C$ ,
- the saturation voltage  $V_{CEsat}$  across the device,
- the power generated by the product  $I_C \cdot V_{CEsat}$ , and
- the maximum junction temperature  $T_{VJ}$  allowed.

In cases where the power semiconductor is a MOSFET, dedicated to be operated in linear mode, the current can be influenced by tuning the gate-source-voltage accordingly. As a consequence, the drain-source-voltage  $V_{DS}$  of the devices changes which in turn impacts the losses. The device must dissipate these losses and the thermal impedance of the device poses the limits here.

For these operating conditions, the FBSOA-diagram features the forward voltage, the current and limits imposed by thermal development. Looking at Figure 2, it becomes obvious that growing losses can only be tolerated for shorter periods of time.



Figure 2. SOA Diagram for the IXTX46N50L

Any combination of forward voltage and current that is found below the correlating lines within the diagram is a legal point of operation as long as the junction temperature remains below the maximum limit and the duration of the loading is properly chosen. De-rating must be considered if the case temperature is different from the 25°C the diagram in Figure 2 refers to.

## 2. Reverse Biased Safe Operating Area (RBSOA)

Power semiconductors like IGBTs or MOSFETs can turn off a current rather quickly but not at infinite speed. As the switching procedure does take some time, transient phenomena happen that need to be considered.

During this short period, when the device turns from conducting into blocking mode, the Reverse Biased Safe Operating Area needs to be respected at any time.

The limits are given by the current which is turned off and the voltage that appears across the device. The plot in Figure 3 schematically displays a turn-off event in detail.



Figure 3. Voltage and current waveforms during a turn-off event

In the graph, it can clearly be seen that the voltage across the device first reaches the DC-link’s voltage level before the current starts declining. Because of the current change rate  $di/dt$  and the inherently contained stray inductances  $L_\sigma$ , the voltage spike  $\Delta V_{CE}$  is added on top of the DC-link voltage. If this spike exceeds the device’s breakdown voltage  $V_{BR}$  – even for a very short period of time – the device will be destroyed.

The square-shaped Reverse Biased Safe Operating Area therefore is given by maximum current  $I_{C,max}$  and the breakdown voltage  $V_{BR}$ , as depicted in Figure 4. Here too, the junction temperature poses a further limit.

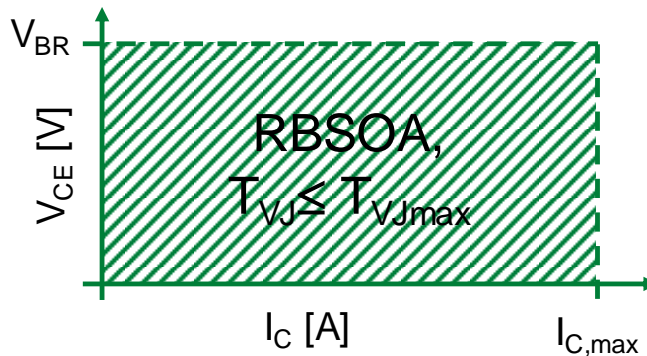

Figure 4. RBSOA-shape, limited by maximum current and breakdown voltage

### 3. Short-Circuit Safe Operating Area (SCSOA)

Devices that feature desaturation, like most IGBTs, can withstand short-circuit events for a distinct duration. Corresponding datasheets highlight this information as Short Circuit Safe Operating Area or SCSOA. Such a datasheet’s excerpt is given in Figure 5.

<b>SCSOA</b>	<i>short circuit safe operating area</i>	$V_{CEK} = 1200\text{ V}$				
$t_{sc}$	<i>short circuit duration</i>	$V_{CE} = 720\text{ V}; V_{GE} = \pm 15$	$T_{VJ} = 125^{\circ}\text{C}$		10	$\mu\text{s}$
$I_{sc}$	<i>short circuit current</i>	$R_G = 6.8\Omega$ ; non-repetitive		450		A

Figure 5. SCSOA information taken from the MDMA280UB1600PTED datasheet

The short circuit condition demands that the IGBT goes into desaturation. In this mode, no further charge carriers remain available which also limits the current. Typically, IGBTs limit the short-circuit current to about three to four times their rated current. In the example in Figure 5, the 160 A-device is expected to limit the short circuit current to 450 A. This situation is tolerable for 10  $\mu\text{s}$  only and limited by thermal development.

### 4. Resulting challenges for the designer

Combining the two areas for Reverse Biased Safe Operation and Short Circuit Safe Operation into a single diagram reveals a gap between them, as pictured in Figure 6.

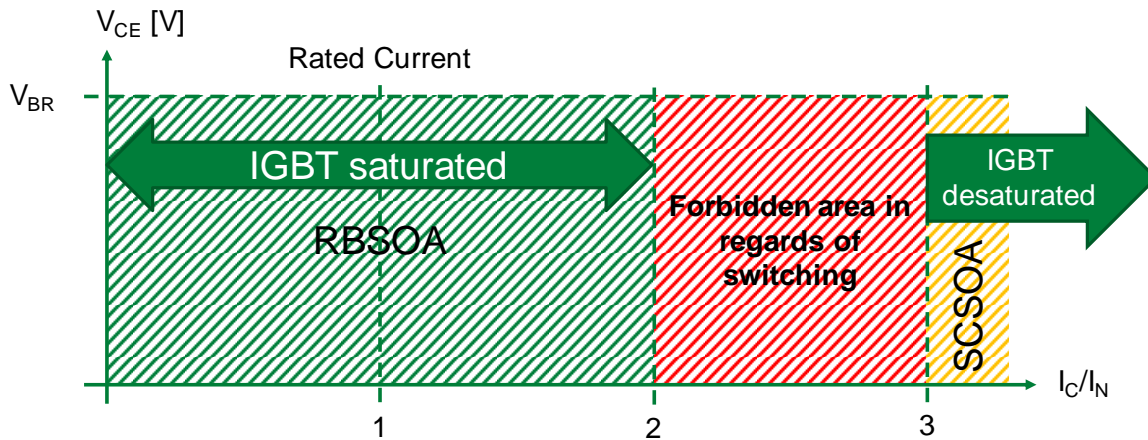

Figure 6. RBSOA, SCSOA, and the undefined region in between

Within the gap marked as forbidden area, located between twice and three times rated current, turning off the device is not allowed as it may lead to its destruction. The root cause of the destruction is found in very high local current densities, transiently forming during switching. The thermal limits in that case are reached already and additional burden due to switching losses leads to exceeding the limits. In turn, single cells on the chip fail and create a connection between collector and emitter. The current can no longer be turned off and the damage grows.

To overcome this situation, techniques to ensure that the IGBT reaches desaturation mode and enters the SCSOA can be used. The simplest way is to wait, instead of reacting on an overcurrent too quickly. Implementing a certain dead-time and fully exploit the 10  $\mu\text{s}$  that the IGBT can withstand the conditions is a valid approach.

Further methods include the so-called 2-Level turn-off. The device is not turned off by immediately cancelling or even reversing the gate-emitter voltage. Instead, the gate-emitter voltage is first reduced to minimize the number of charge carriers available for current transport. This speeds up reaching the desaturation stage. A few microseconds later, when desaturation is reached, the gate-emitter voltage is set to zero or reversed. The device is then safely turned off within the SCSOA-specification.

This fact becomes particularly important when handling overcurrent situations.

From a given setup, measurements from a destructive turn-off event seen in Figure 7 were analyzed:



Figure 7. Measurement results from a destructive turn-off event

As the measurement reveals, the current turned off was well below the 450 A short-circuit limit. The gate-emitter-voltage was well-controlled, the time it took to turn off was below the 10 µs-limit and the overvoltage spike did not exceed the 1200 V the device is rated for. Still, the IGBT was destroyed, and the question raised, why so?

Entering the point of the turn-off into the diagram in Figure 6, the violation that happens becomes obvious in Figure 8:

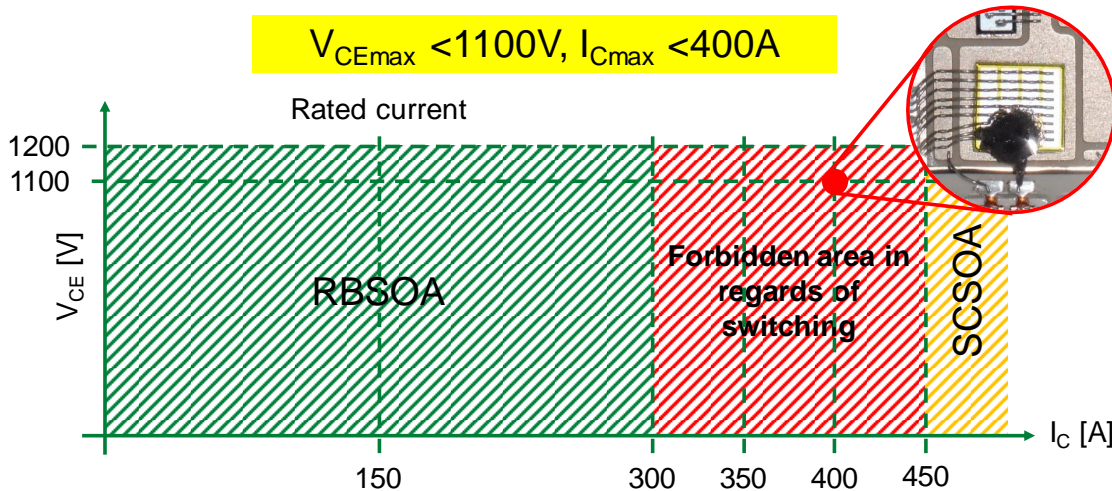

Figure 8. Locating the point of turn-off

Clearly, the switching event was done within the no-go-area with the destructive effect previously predicted.

To clear the situation, the control strategy for short circuit was changed. Instead of reacting on the overcurrent signal instantly and turn off after just 2.5  $\mu\text{s}$ , a blanking time of about 6  $\mu\text{s}$  was added.

Figure 9 represents the measurement done in the same setup.



Figure 9. Properly turned off overcurrent or short-circuit event

While the red dot marks the former turn-off point, the current is now allowed to grow further. At first sight, this seems to worsen the situation as the losses and, as such, the chip temperature grows. However, after about 6  $\mu\text{s}$  the IGBT reaches desaturation, enters the SCSOA and the turn-off after 8  $\mu\text{s}$  is safely done without damaging the component.

MOSFETs, other than IGBTs, don't feature a dedicated SCSOA. At high currents, the MOSFET goes into linear operation as depicted in the FBSOA-diagram, so short-circuit and overcurrent events are covered by diagrams as given in Figure 2.

## 5. Conclusion

Handling overcurrent events, especially short circuit events, is challenging but manageable. Doing so while remaining within the given specifications can successfully be achieved.

Simply turning off a detected overcurrent as fast as possible may not be the best strategy as it may lead to damage caused by so-called RBSOA-exceedance. Ensuring that the IGBT reaches desaturation is a key factor in handling short circuit events with this technology.

For additional information please visit [www.Littelfuse.com/powersemi](http://www.Littelfuse.com/powersemi)

Disclaimer Notice - This document is provided by Littelfuse, Inc. ("Littelfuse") for informational and guideline purposes only. Littelfuse assumes no liability for errors or omissions in this document or for any of the information contained herein. Information is provided on an "as is" and "with all faults" basis for evaluation purposes only. Applications described are for illustrative purposes only and Littelfuse makes no representation that such applications will be suitable for the customer's specific use without further testing or modification. Littelfuse expressly disclaims all warranties, whether express, implied or statutory, including but not limited to the implied warranties of merchantability and fitness for a particular purpose, and non-infringement. It is the customer's sole responsibility to determine suitability for a particular system or use based on their own performance criteria, conditions, specific application, compatibility with other components, and environmental conditions. Customers must independently provide appropriate design and operating safeguards to minimize any risks associated with their applications and products.

Littelfuse products are not designed for, and shall not be used for, any purpose (including, without limitation, automotive, military, aerospace, medical, life-saving, life-sustaining or nuclear facility applications, devices intended for surgical implant into the body, or any other application in which the failure or lack of desired operation of the product may result in personal injury, death, or property damage) other than those expressly forth in applicable Littelfuse product documentation. Littelfuse shall not be liable for any claims or damages arising out of products used in applications not expressly intended by Littelfuse as set forth in applicable Littelfuse documentation.

Read complete Disclaimer Notice at [www.littelfuse.com/disclaimer-electronics](http://www.littelfuse.com/disclaimer-electronics)