

Mounting Modules with Exposed Backside DCBs

Objectives

This application note discusses mounting and handling for Littelfuse power semiconductor modules with a backside that is formed by a Direct Copper Bond structure (DCB), as depicted in **Figure 1**. Information is provided focusing on the fact that a DCB-structure is ceramic in nature and demands special precautions to be considered during mounting.



Figure 1. Littelfuse Y4-Package with Exposed DCB-Backside

Applications

- Motor drives
- PV inverters and UPS systems
- DC-DC converters
- Welding

Target Audience

This document is intended for potential adopters of power semiconductors who want to determine the appropriate mounting and cooling solution to ensure proper package mounting and thermal performance.

Contact Information

For more information on the topic of mounting Y-packaged devices, contact the Littelfuse Power Semiconductor team of product and applications experts:

- North America – NA_PowerSemi_Tech@Littelfuse.com
- Central & South America – CSA_PowerSemi_Tech@Littelfuse.com
- Europe, Middle East, & Africa – EMEA_PowerSemi_Tech@Littelfuse.com
- Asia, Australia, & Pacific Islands – APAC_PowerSemi_Tech@Littelfuse.com

Table of Contents

1. Introduction	3
2. Recommended Heat Sink Assembly	3
2.1. Heat Sink Preparation	4
2.2. Use of Thermal Interface Materials	4
2.3. Detailed Mounting Procedure	5
3. Further Mechanical Aspects	6
3.1. Metric Thread, Imperial Thread, Self-tapping Screws	6
3.2. Mounting the Electronics and DC-link Components	6
3.3. Design Verification	7
3.4. Insulation Management	8
4. Conclusion	8

List of Figures

Figure 1. Littelfuse Y4-Package with Exposed DCB-Backside	1
Figure 2. Package Illustration	3
Figure 3. Sequence of Mounting the Module to a Heat Sink	3
Figure 4. Heat Sink's Surface Requirements to Mount Y-Package Power Modules	4
Figure 5. Improving Thermal Transfer by using Thermal Interface Material (TIM)	4
Figure 6. Bolting Down the Screw – Incorrect and Correct Method	5
Figure 7. Tightening Sequence for Modules with a 4-screw Arrangement	5
Figure 8. Phillips-style Screws and Captivated Washers per ISO 10644	6
Figure 9. Module Assembly with DC-link Attached	6
Figure 10. Results from Inspecting the Pressure Distribution using Color-Changing Film	7
Figure 11. Piezo-electric, Tactile Pressure Sensor, and Captured Results	8

List of Tables

Table 1. Mounting Sequence for Y-Packages with Exposed DCB	5
--	---

1. Introduction

A multitude of power semiconductors feature Direct Copper Bonded (DCB) substrate as an exposed backside. The DCB substrate inherently offers electrical insulation and allows multiple semiconductor chips on one substrate to form different circuit topologies. Potting gel inside the plastic housing provides excellent sealing and semiconductor protection. The backside copper of the DCB substrate is exposed and acts as large-area connection between the semiconductor and a heat sink. An illustration of such packages is shown in **Figure 2**.



Figure 2. Package Illustration

These packages provide unique features for power electronic applications, including:

- High electric insulation strength
- High thermal performance
- Higher current-carrying capability compared to discrete TO-style packages
- Internal construction is designed to reduce parasitic effects like stray inductance and parasitic capacitances, leading to improved EMI-performance

2. Recommended Heat Sink Assembly

The Y-package family is designed to be mounted onto a heat sink using screws. A layer of Thermal Interface Material (TIM) is needed to ensure a high thermal conductivity from the exposed DCB to the heatsink. After the process of applying TIM is completed, the module can be mounted to a heat sink using mounting screws. An example of the module and assembly is shown in **Figure 3**.



Figure 3. Sequence of Mounting the Module to a Heat Sink

2.1. Heat Sink Preparation

When the package is mounted, the copper side of the DCB substrate becomes the crucial interface for thermal management. A heat sink needs to be mounted for heat dissipation, as depicted in **Figure 3**. Y-packages have dedicated mounting holes, and the appropriate dimensions for these mounting holes are listed in the corresponding datasheets.

To ensure a low value of thermal resistance, the contact surface of the heat sink must be flat, even, and clean. For the mounting area, the surface quality has to achieve or exceed the values given in **Figure 4**.

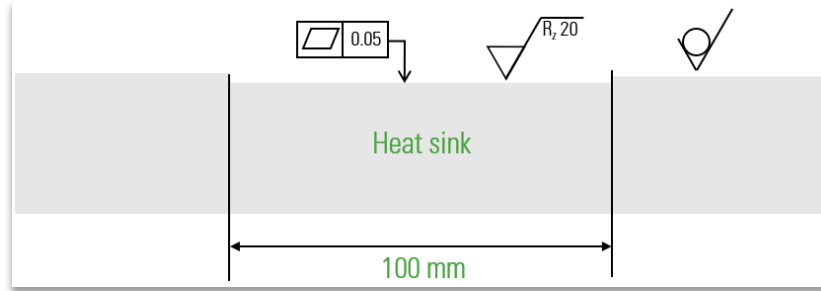

Figure 4. Heat Sink's Surface Requirements to Mount Y-Package Power Modules

Prior to mounting, cleaning all surfaces with a suitable cleaning agent is advised.

2.2. Use of Thermal Interface Materials

The use of Thermal Interface Materials (TIM) is essential to achieve suitable contact between the device's base and the heat sink's surface. This reduces the thermal resistance case-to-heatsink, R_{thch} . Thermal interface materials are available as thermal pad and thermal grease or compound. Unlike discrete packages, where the copper cooling pad is usually electrically active, Y-family packages feature a DCB structure which uses a layer of ceramic as electrical isolation. With up to 4000 V isolation voltage, these packages provide the option to use electrically non-isolated thermal interface materials. The use of an interface material with isolation, such as silicone-pads sometimes used for discrete packaged devices, is not recommended. These materials inherently exhibit a higher thermal resistance compared to thermal grease/compound or conductive thermal pads.

The thermal interface materials should be applied evenly to the device's base plate or the heat sink's surface. Ideally, screen printing is used to achieve accurate and reproduceable results. A screen thickness of 100 μm with a fill-factor of 70-80% and a regular pattern of honeycomb-shaped openings has proven to be a reasonable approach.

As no electrical isolation is required from the TIM layer, it is recommended to have a very thin layer of TIM so that the material just fills the gaps and voids between the device's copper pad and the heat sink, as seen in **Figure 5**.

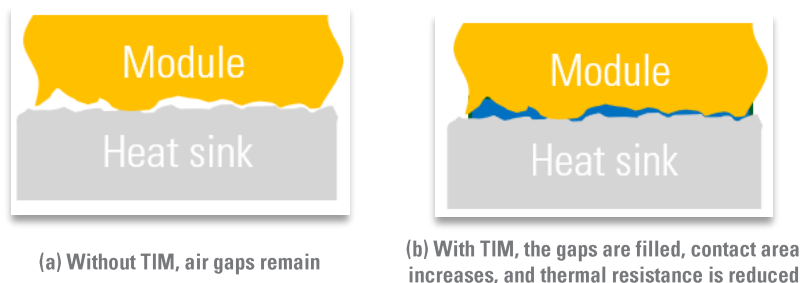

Figure 5. Improving Thermal Transfer by using Thermal Interface Material (TIM)

If a solid thermal pad is considered, softer materials with high thermal conductivity are preferred to better fill the gaps. The thermal pad should be as thin as possible to provide the lowest thermal resistance. The mounting mechanism using screws provides proper pressure on the thermal interface material to ensure a low value of thermal resistance.

2.3. Detailed Mounting Procedure

Mounting the module using screws inherently achieves mounting forces in a range of kilonewton. Though the DCB is highly resistant to pressure, it is very sensitive towards bending. Therefore, careful handling and step-by-step tightening of the screws is essential to achieve homogeneous pressure distribution and prevent bending the DCB.

Besides the mounting forces, an even distribution of thermal interface material is important. Uneven distribution, particularly with higher amount of material in the center of the module, may also lead to high local forces that could damage the DCB.

Using solid sheets as thermal interface material is not a recommended solution as these typically remain too thick and limit the module’s thermal performance. Additionally, they may lead to further issues during mounting.

Figure 6 illustrates that the module lifts on one side if the first screw is bolted down too much and shows a two-step sequence to prevent this from happening.



Figure 6. Bolting Down the Screw – Incorrect and Correct Method

Depending on the package, either two or four screws need to be tightened. If two screws are used, tightening takes place in an alternating pattern. For four screws, the sequence given in **Figure 7** needs to be considered.



Figure 7. Tightening Sequence for Modules with a 4-screw Arrangement

For package types TO-240, Y4, and Y2, the tightening procedure is summarized in **Table 1**.

Table 1. Mounting Sequence for Y-Packages with Exposed DCB

Package Type	Screw Diameter	Step 1	Step 2	Step 3	Step 4
TO-240	5 mm	Bolt down all screws so that the screw’s head touches the washer	Apply 0.5Nm to both screws	Wait for the assembly to settle. Waiting time depends on the TIM in use and varies from 5-10 minutes	Apply 3Nm to both screws
Y4	6 mm		Apply 0.5Nm to both screws		Apply 2.5Nm to both screws
Y2	5 mm		Apply 0.5Nm to screws in a sequence 1-2-3-4		Apply 4Nm to screws in a sequence 1-2-3-4

Note: If imperial screws are preferred for mounting, 5 mm is most closely represented by a 6-32 screw and 6 mm is best met by ¼”.

3. Further Mechanical Aspects

Besides the data and procedures to mount power electronic components, influences that arise from mechanical parts and physics need thorough attention. Some details that appear to be of minor impact can lead to unexpected effects with highly detrimental consequences.

3.1. Metric Thread, Imperial Thread, Self-tapping Screws

The recommended material for mounting the module to the heat sink is a metric screw with spring-washer and captivated washer, as described by ISO 10644. Zinc- or nickel-plated steel screws with a property class 6.8 or higher, as depicted in **Figure 8**, are recommended.



Figure 8. Phillips-style Screws and Captivated Washers per ISO 10644

Using screws with imperial scale is an option too. However, due to the different diameters and thread's pitch, the ratio between turning angle, torque, and the resulting mounting forces also changes. Purely translating newton meter (Nm) into pound inches (lb-in) might result in misleading values. Individual verification of the result is advised to ensure that proper pressure and pressure distribution is achieved.

If self-tapping screws similar to those described in DIN7504-K/ ISO15480 are preferred, dedicated tests are needed to correlate torque, turning angle, and mounting force. As the torque mainly depends on the drill-hole's diameter and the heat sink material, no general recommendation can be made. Using washers and spring-washers in combination with self-tapping screws is advised.

3.2. Mounting the Electronics and DC-link Components

DCB-based modules are robust with regards to applied pressure, but highly sensitive towards pulling forces. Pulling forces can be a consequence of dynamic influences like shock and vibration but can result from the combination of materials used in the construction and their tolerances.

A mechanical assembly has to ensure that the resulting forces to the terminals remain directed as highlighted in **Figure 9**.

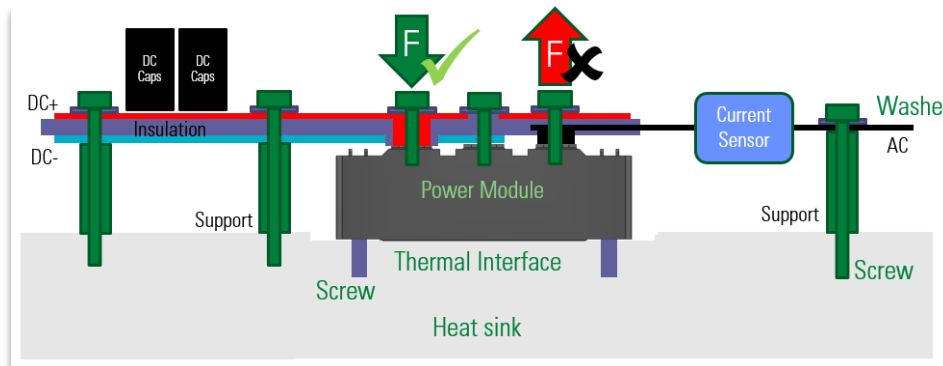

Figure 9. Module Assembly with DC-link Attached

Applying a total force of up to 100 N pressure to the module is tolerable while no pulling force may remain after mounting is complete. To achieve this, properly dimensioned supports have to be installed. These prevent static forces as well as dynamic events from reaching the terminals. Including all tolerances, the supports' length needs to remain below the height of the module in use.

As can be seen in **Figure 9**, larger components like DC-link capacitors, output terminals, or heavy current sensors demand additional support. In case of vibration, undamped oscillating masses may inject destructive forces into the power component.

To mount the DC-link-structure to the modules, either as PCB or laminated copper plates, the screws mandatorily need to comply with the information given in the datasheet. The maximum length of the screws depends on the thickness of the structure mounted on top of the modules. Caution is advised as extra-long screws can damage the housing, enter electrically sensitive areas, and cause severe damage.

Because the nuts embedded in the modules feature metric threads, the use of screws according to imperial scale is not an option. The nuts are held in place by the module's housing. Applying too high a torque can lead to damage of the housing and in turn, loss of function. Especially in combination with oils used to prevent corrosion, the friction during mounting can change massively, leading to a distortion in the ratio of torque and turning angle. The same applies when using adhesive-based thread lockers.

When handling sub-assemblies, supporting the whole setup to move it is recommended. Using the bus bar or the PCB as a handle involves a high risk of applying pulling forces and therefore should be prevented.

If a module is being replaced, ensure there is no contamination in the threaded hole, for example, thermal paste that has been solvent washed into the threads, as this may limit the screws' engagement, resulting in false fastener tension and module clamping force. In situations where blind holes are not required for maintaining corrosion or pressure sealing performance, threaded through holes can be used as these can be brushed or washed clean and inspected easily.

3.3. Design Verification

To verify the mounting procedure during the design phase, monitoring the pressure distribution on the DCB-area is advised. Littelfuse recommends the use of Fuji Prescale film or a similar film product to confirm the pressure uniformity. These films are available in several different pressure ranges and should be inserted between the semiconductor device and the heat sink prior to mounting.

Once pressure is applied to an area of the film, the material irreversibly changes color to indicate the local pressure. The pressure distribution achieved with a given setup can be judged by disassembling the module and inspecting the film. Uniform color change signals uniform pressure. Results achieved on a circular device, including a suitable pressure distribution and a non-uniform result, are summarized in **Figure 10**.

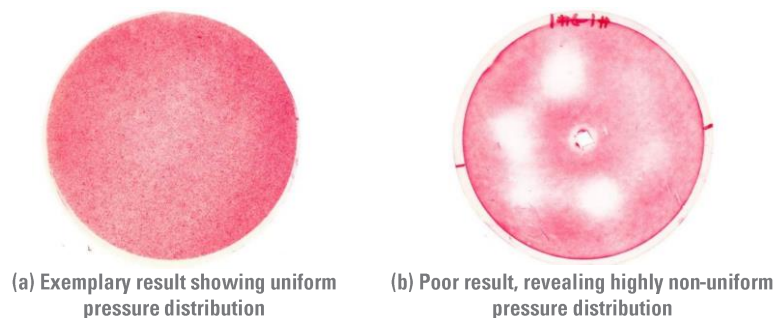

Figure 10. Results from Inspecting the Pressure Distribution using Color-Changing Film

Another option to verify the mounting procedure is by using pressure-sensitive electrical sensor arrays. These consist of a matrix of pressure-sensitive resistors that can be measured by dedicated equipment.

The result is displayed as a color-map. In contrast to the irreversible color change of the film, these sensors allow monitoring in real-time and can be reused. A common sensor and a typical result from such a measurement is shown in **Figure 11**.

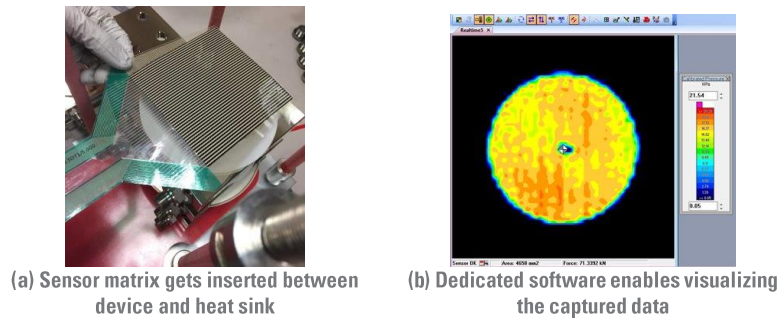

Figure 11. Piezo-electric, Tactile Pressure Sensor, and Captured Results

This verification only targets monitoring the mounting procedure and should be done without the thermal interface material attached to the base of the semiconductor component to prevent contamination of the sensor’s surface.

Both the sensor types need to be removed from the setup afterwards. The result demonstrated by the measurement can substantiate that the chosen assembly technique reproducibly leads to the correct magnitude of force and to homogeneous pressure distribution.

3.4. Insulation Management

Two major parameters require to be considered when PCB layouts and DC-link-components are designed:

- Clearance – the shortest possible distance between two points, and
- Creepage distance – the shortest path from one point to another point along an uninterrupted line on solid material

Particularly when using laminated bus bar structures, isolating the layers from each other remains an important task. In high-voltage environments, arcing between different voltage levels has to be prevented. Arcing takes place over air-gaps – clearance distances – so the voltage level expected in the final system defines the distance between pads and traces as well as between active areas and heat sinks or other grounded parts. Even if the clearance between two points is chosen to be high enough, the insulation strength can be reduced by conductive particles over a longer period. This depends on the degree of pollution, which relates to the ambient conditions the device is used in. IEC60664-1 gives an insight into the relevant conditions that need to be considered to determine the creepage and clearance distances in a targeted design.

4. Conclusion

Packages with exposed DCBs are more challenging to mount than devices that feature a solid base plate. Care needs to be taken to not bend the DCB during the process and a mechanical arrangement is designed to prevent pulling forces at the terminals. Applying thermal interface material by a well-controlled screen-printing process further helps to reduce unwanted mechanical stress to the DCB.

If these aspects are considered, mounting the devices can be done successfully by implementing established procedures and processes.

For additional information please visit www.Littelfuse.com/powersemi

Disclaimer Notice - This document is provided by Littelfuse, Inc. (“Littelfuse”) for informational and guideline purposes only. Littelfuse assumes no liability for errors or omissions in this document or for any of the information contained herein. Information is provided on an “as is” and “with all faults” basis for evaluation purposes only. Applications described are for illustrative purposes only and Littelfuse makes no representation that such applications will be suitable for the customer’s specific use without further testing or modification. Littelfuse expressly disclaims all warranties, whether express, implied or statutory, including but not limited to the implied warranties of merchantability and fitness for a particular purpose, and non-infringement. It is the customer’s sole responsibility to determine suitability for a particular system or use based on their own performance criteria, conditions, specific application, compatibility with other components, and environmental conditions. Customers must independently provide appropriate design and operating safeguards to minimize any risks associated with their applications and products.

Littelfuse products are not designed for, and shall not be used for, any purpose (including, without limitation, automotive, military, aerospace, medical, life-saving, life-sustaining or nuclear facility applications, devices intended for surgical implant into the body, or any other application in which the failure or lack of desired operation of the product may result in personal injury, death, or property damage) other than those expressly forth in applicable Littelfuse product documentation. Littelfuse shall not be liable for any claims or damages arising out of products used in applications not expressly intended by Littelfuse as set forth in applicable Littelfuse documentation.

Read complete Disclaimer Notice at www.littelfuse.com/disclaimer-electronics

Thyristor Module

$$V_{RRM} = 2 \times 1600 \text{ V}$$

$$I_{TAV} = 49 \text{ A}$$

$$V_T = 1.34 \text{ V}$$

Phase leg

Part number

MCC44-16io1B

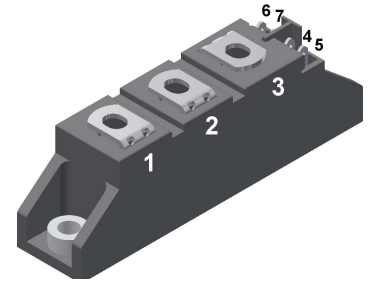

Backside: isolated

 E72873

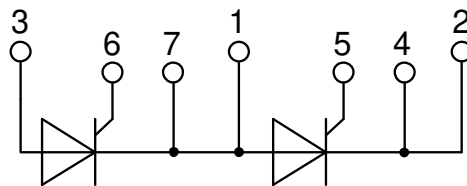

Features / Advantages:

- Thyristor for line frequency
- Planar passivated chip
- Long-term stability
- Direct Copper Bonded Al₂O₃-ceramic

Applications:

- Line rectifying 50/60 Hz
- Softstart AC motor control
- DC Motor control
- Power converter
- AC power control
- Lighting and temperature control

Package: TO-240AA

- Isolation Voltage: 4800 V~
- Industry standard outline
- RoHS compliant
- Soldering pins for PCB mounting
- Base plate: DCB ceramic
- Reduced weight
- Advanced power cycling

Disclaimer Notice

Information furnished is believed to be accurate and reliable. However, users should independently evaluate the suitability of and test each product selected for their own applications. Littelfuse products are not designed for, and may not be used in, all applications. Read complete Disclaimer Notice at www.littelfuse.com/disclaimer-electronics.

Thyristor			Ratings			
Symbol	Definition	Conditions	min.	typ.	max.	Unit
$V_{RSM/DSM}$	max. non-repetitive reverse/forward blocking voltage	$T_{VJ} = 25^{\circ}\text{C}$			1700	V
$V_{RRM/DRM}$	max. repetitive reverse/forward blocking voltage	$T_{VJ} = 25^{\circ}\text{C}$			1600	V
I_{RD}	reverse current, drain current	$V_{R/D} = 1600\text{ V}$	$T_{VJ} = 25^{\circ}\text{C}$		100	μA
		$V_{R/D} = 1600\text{ V}$	$T_{VJ} = 125^{\circ}\text{C}$		5	mA
V_T	forward voltage drop	$I_T = 100\text{ A}$	$T_{VJ} = 25^{\circ}\text{C}$		1.34	V
		$I_T = 200\text{ A}$			1.75	V
		$I_T = 100\text{ A}$	$T_{VJ} = 125^{\circ}\text{C}$		1.34	V
		$I_T = 200\text{ A}$			1.80	V
I_{TAV}	average forward current	$T_C = 85^{\circ}\text{C}$	$T_{VJ} = 125^{\circ}\text{C}$		49	A
$I_{T(RMS)}$	RMS forward current	180° sine			77	A
V_{T0}	threshold voltage	} for power loss calculation only	$T_{VJ} = 125^{\circ}\text{C}$		0.85	V
r_T	slope resistance				5.3	m Ω
R_{thJC}	thermal resistance junction to case				0.53	K/W
R_{thCH}	thermal resistance case to heatsink			0.2		K/W
P_{tot}	total power dissipation		$T_C = 25^{\circ}\text{C}$		180	W
I_{TSM}	max. forward surge current	$t = 10\text{ ms}; (50\text{ Hz}), \text{ sine}$	$T_{VJ} = 45^{\circ}\text{C}$		1.15	kA
		$t = 8,3\text{ ms}; (60\text{ Hz}), \text{ sine}$	$V_R = 0\text{ V}$		1.24	kA
		$t = 10\text{ ms}; (50\text{ Hz}), \text{ sine}$	$T_{VJ} = 125^{\circ}\text{C}$		980	A
		$t = 8,3\text{ ms}; (60\text{ Hz}), \text{ sine}$	$V_R = 0\text{ V}$		1.06	kA
I^2t	value for fusing	$t = 10\text{ ms}; (50\text{ Hz}), \text{ sine}$	$T_{VJ} = 45^{\circ}\text{C}$		6.62	kA ² s
		$t = 8,3\text{ ms}; (60\text{ Hz}), \text{ sine}$	$V_R = 0\text{ V}$		6.40	kA ² s
		$t = 10\text{ ms}; (50\text{ Hz}), \text{ sine}$	$T_{VJ} = 125^{\circ}\text{C}$		4.80	kA ² s
		$t = 8,3\text{ ms}; (60\text{ Hz}), \text{ sine}$	$V_R = 0\text{ V}$		4.63	kA ² s
C_J	junction capacitance	$V_R = 400\text{ V } f = 1\text{ MHz}$	$T_{VJ} = 25^{\circ}\text{C}$		54	pF
P_{GM}	max. gate power dissipation	$t_p = 30\text{ }\mu\text{s}$	$T_C = 125^{\circ}\text{C}$		10	W
		$t_p = 300\text{ }\mu\text{s}$			5	W
P_{GAV}	average gate power dissipation				0.5	W
$(di/dt)_{cr}$	critical rate of rise of current	$T_{VJ} = 125^{\circ}\text{C}; f = 50\text{ Hz}$ repetitive, $I_T = 150\text{ A}$			150	A/ μs
		$t_p = 200\text{ }\mu\text{s}; di_G/dt = 0.45\text{ A}/\mu\text{s}; I_G = 0.45\text{ A}; V = \frac{2}{3} V_{DRM}$ non-repet., $I_T = 49\text{ A}$			500	A/ μs
$(dv/dt)_{cr}$	critical rate of rise of voltage	$V = \frac{2}{3} V_{DRM}$ $R_{GK} = \infty$; method 1 (linear voltage rise)	$T_{VJ} = 125^{\circ}\text{C}$		1000	V/ μs
V_{GT}	gate trigger voltage	$V_D = 6\text{ V}$	$T_{VJ} = 25^{\circ}\text{C}$		1.5	V
			$T_{VJ} = -40^{\circ}\text{C}$		1.6	V
I_{GT}	gate trigger current	$V_D = 6\text{ V}$	$T_{VJ} = 25^{\circ}\text{C}$		100	mA
			$T_{VJ} = -40^{\circ}\text{C}$		200	mA
V_{GD}	gate non-trigger voltage	$V_D = \frac{2}{3} V_{DRM}$	$T_{VJ} = 125^{\circ}\text{C}$		0.2	V
I_{GD}	gate non-trigger current				10	mA
I_L	latching current	$t_p = 10\text{ }\mu\text{s}$	$T_{VJ} = 25^{\circ}\text{C}$		450	mA
		$I_G = 0.45\text{ A}; di_G/dt = 0.45\text{ A}/\mu\text{s}$				
I_H	holding current	$V_D = 6\text{ V } R_{GK} = \infty$	$T_{VJ} = 25^{\circ}\text{C}$		200	mA
t_{gd}	gate controlled delay time	$V_D = \frac{1}{2} V_{DRM}$	$T_{VJ} = 25^{\circ}\text{C}$		2	μs
		$I_G = 0.45\text{ A}; di_G/dt = 0.45\text{ A}/\mu\text{s}$				
t_q	turn-off time	$V_R = 100\text{ V}; I_T = 120\text{ A}; V = \frac{2}{3} V_{DRM}$ $di/dt = 10\text{ A}/\mu\text{s } dv/dt = 20\text{ V}/\mu\text{s } t_p = 200\text{ }\mu\text{s}$	$T_{VJ} = 100^{\circ}\text{C}$		150	μs



Package TO-240AA				Ratings			
Symbol	Definition	Conditions	min.	typ.	max.	Unit	
I_{RMS}	RMS current	per terminal			200	A	
T_{VJ}	virtual junction temperature		-40		125	°C	
T_{op}	operation temperature		-40		100	°C	
T_{stg}	storage temperature		-40		125	°C	
Weight					81	g	
M_D	mounting torque		2.5		4	Nm	
M_T	terminal torque		2.5		4	Nm	
$d_{Spp/App}$	creepage distance on surface striking distance through air	terminal to terminal	13.0	9.7		mm	
$d_{Spb/Apb}$		terminal to backside	16.0	16.0		mm	
V_{ISOL}	isolation voltage	t = 1 second		4800		V	
		t = 1 minute	50/60 Hz, RMS; $I_{ISOL} \leq 1$ mA	4000		V	

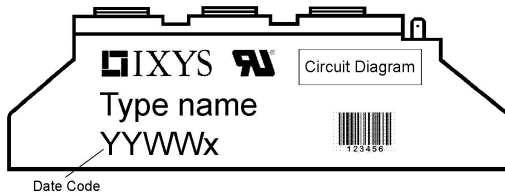

Ordering	Ordering Number	Marking on Product	Delivery Mode	Quantity	Code No.
Standard	MCC44-16io1B	MCC44-16io1B	Box	36	452920

Similar Part	Package	Voltage class
MCMA50P1600TA	TO-240AA-1B	1600
MCMA65P1600TA	TO-240AA-1B	1600

Equivalent Circuits for Simulation

* on die level

$T_{VJ} = 125^{\circ}\text{C}$

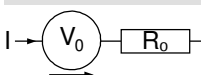

Thyristor

$V_{0\ max}$	threshold voltage	0.85	V
$R_{0\ max}$	slope resistance *	4.1	mΩ



Outlines TO-240AA

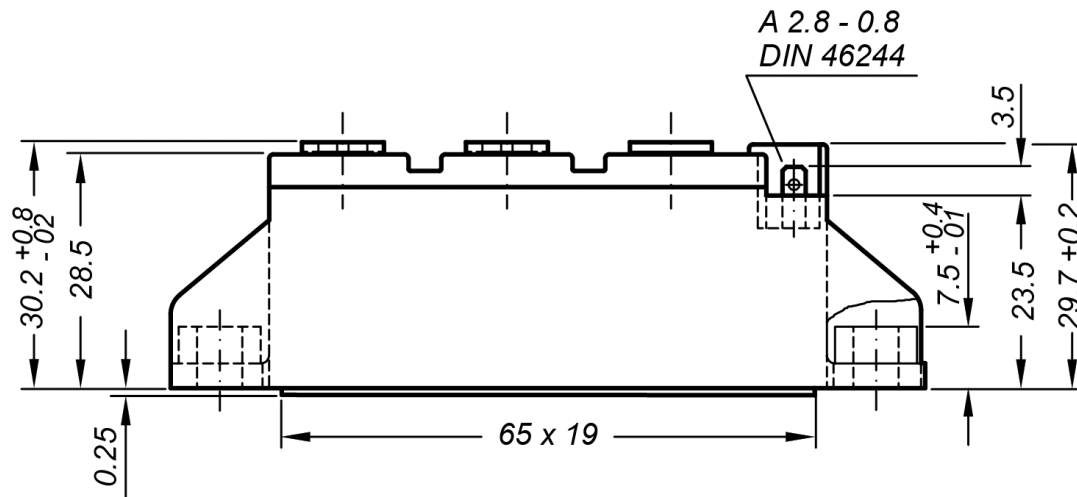

General tolerance: DIN ISO 2768 class „c“

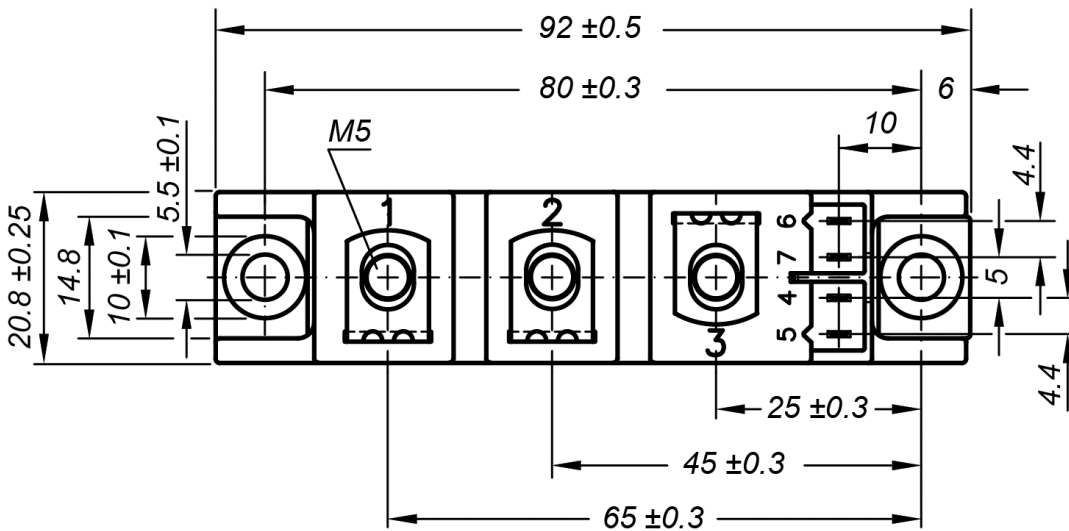

Optional accessories for modules

Keyed gate/cathode twin plugs with wire length = 350 mm, gate = white, cathode = red

Type ZY 200L (L = Left for pin pair 4/5) } UL 758, style 3751
 Type ZY 200R (R = Right for pin pair 6/7) }

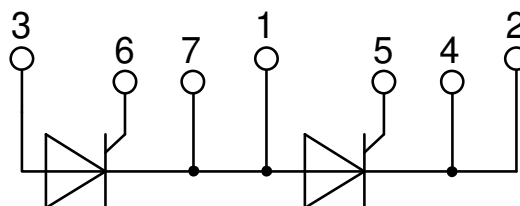

Thyristor

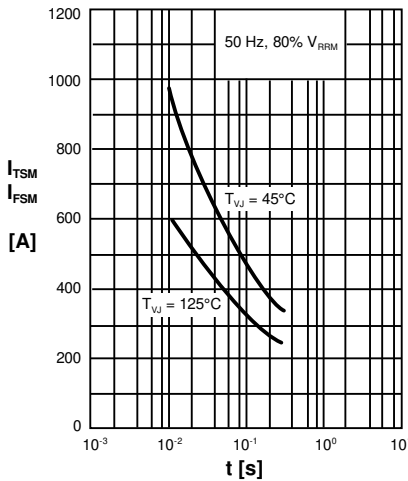

Fig. 1 Surge overload current
 I_{TSM} , I_{FSM} : Crest value, t : duration

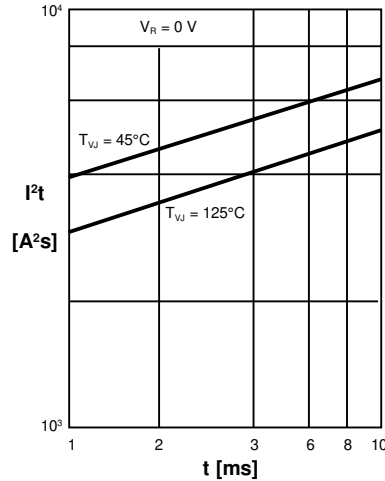

Fig. 2 I^2t versus time (1-10 ms)

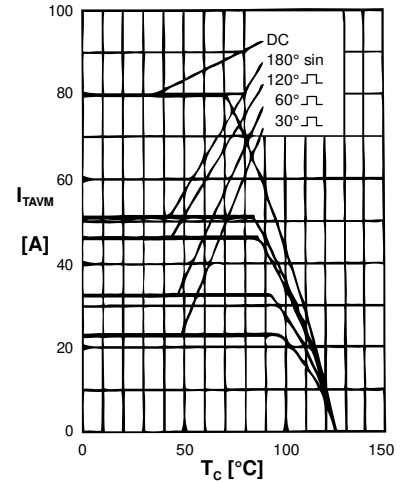

Fig. 3 Maximum forward current at case temperature

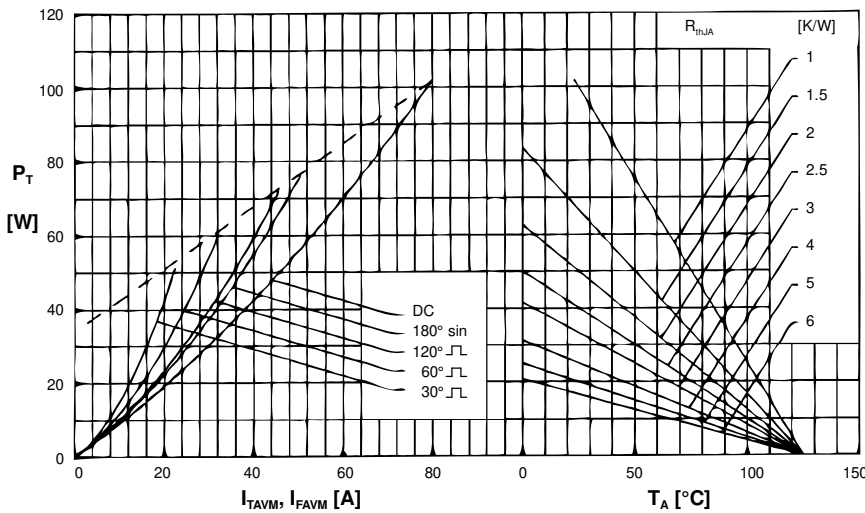

Fig. 4 Power dissipation vs. onstate current and ambient temperature (per thyristor/diode)

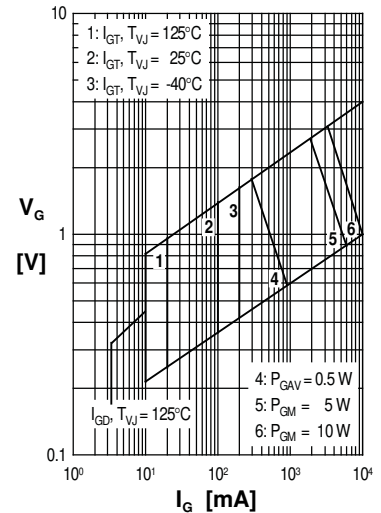

Fig. 5 Gate trigger characteristics

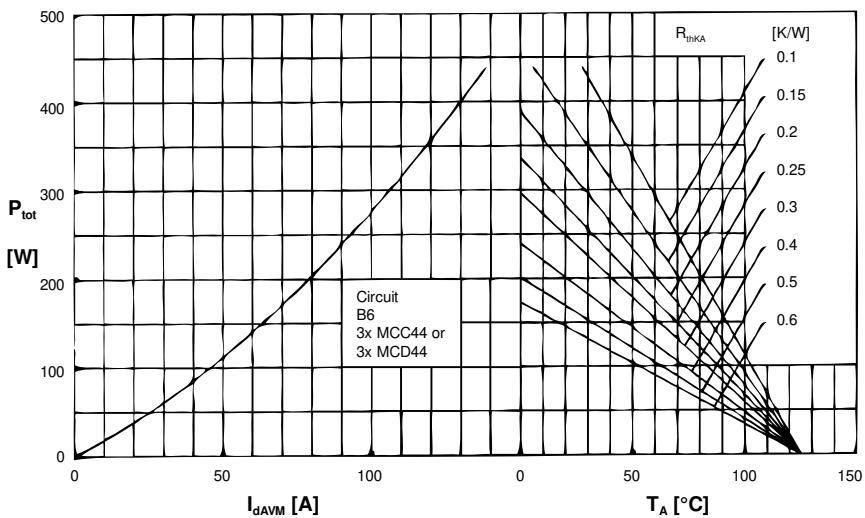

Fig. 6 Three phase rectifier bridge: Power dissipation versus direct output current and ambient temperature

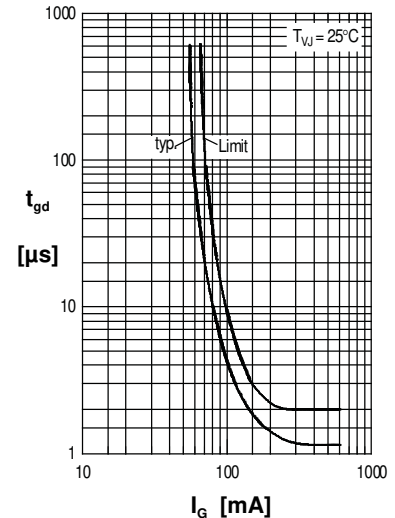

Fig. 7 Gate trigger delay time

Thyristor

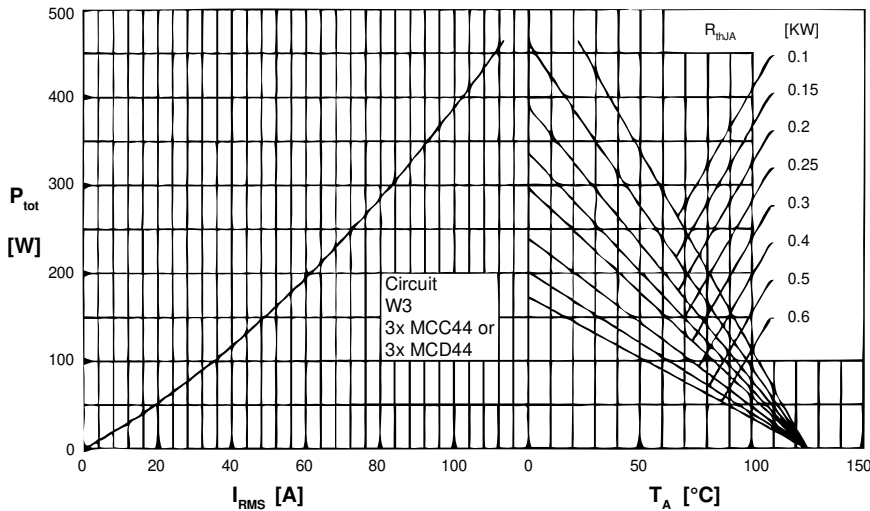

Fig. 8 Three phase AC-controller: Power dissipation versus RMS output current and ambient temperature

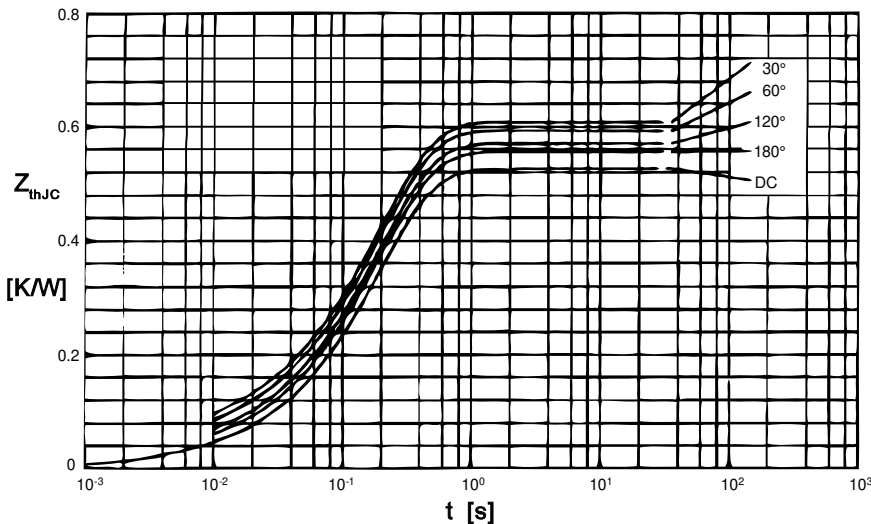

Fig. 9 Transient thermal impedance junction to case (per thyristor)

R_{thJC} for various conduction angles d:

d	R_{thJC} [KW]
DC	0.53
180°	0.55
120°	0.58
60°	0.60
30°	0.62

Constants for Z_{thJC} calculation:

i	R_{thi} [KW]	t_i [s]
1	0.015	0.0035
2	0.026	0.0200
3	0.489	0.1950

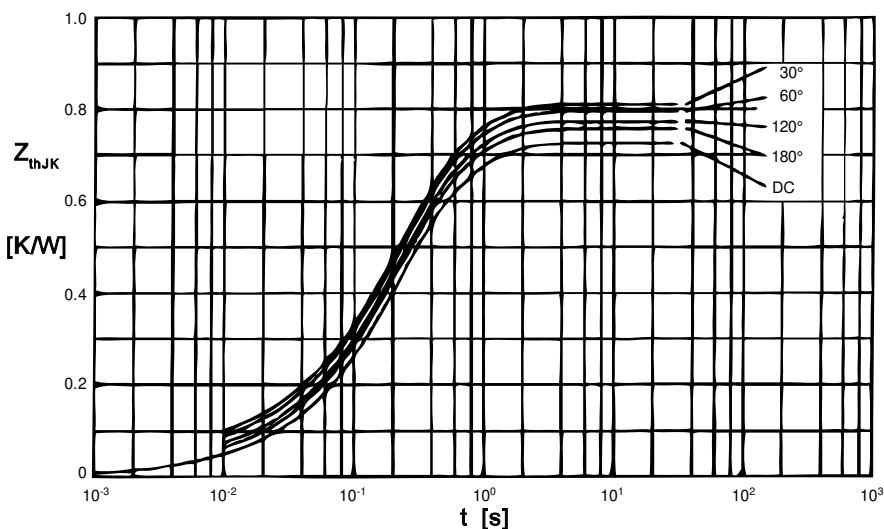

Fig. 10 Transient thermal impedance junction to heatsink (per thyristor)

R_{thJK} for various conduction angles d:

d	R_{thJK} [KW]
DC	0.73
180°	0.75
120°	0.78
60°	0.80
30°	0.82

Constants for Z_{thJK} calculation:

i	R_{thi} [KW]	t_i [s]
1	0.015	0.0035
2	0.026	0.0200
3	0.489	0.0195
4	0.200	0.6800