

Thyristor Module

3~ Rectifier
$V_{RRM} = 1800\text{ V}$
$I_{DAV} = 120\text{ A}$
$I_{FSM} = 500\text{ A}$

3~ Rectifier Bridge, half-controlled (high-side) + free wheeling Diode

Part number

MCMA120UJ1800ED

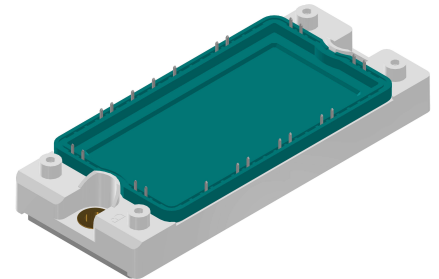

Backside: isolated

 E72873

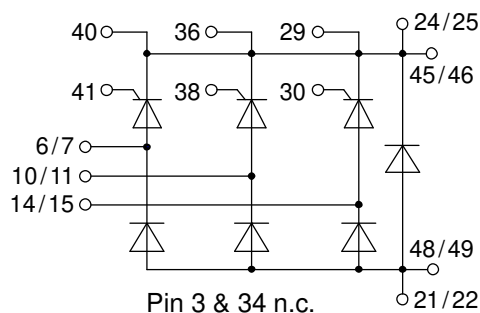

Features / Advantages:

- Thyristor/Standard Rectifier for line frequency
- Planar passivated chips
- Long-term stability
- Low forward voltage drop
- Leads suitable for PC board soldering
- Copper base plate with Direct Copper Bonded Al₂O₃-ceramic
- Improved temperature and power cycling

Applications:

- Diode for main rectification
- For single and three phase bridge configurations
- Supplies for DC power equipment
- Input rectifiers for PWM inverter
- Battery DC power supplies
- Field supply for DC motors

Package: E2-Pack

- Isolation Voltage: 3600 V~
- Industry standard outline
- RoHS compliant
- Soldering pins for PCB mounting
- Height: 17 mm
- Base plate: Copper internally DCB isolated
- Advanced power cycling
- Phase Change Material available

Disclaimer Notice

Information furnished is believed to be accurate and reliable. However, users should independently evaluate the suitability of and test each product selected for their own applications. Littelfuse products are not designed for, and may not be used in, all applications. Read complete Disclaimer Notice at www.littelfuse.com/disclaimer-electronics.

Rectifier			Ratings			
Symbol	Definition	Conditions	min.	typ.	max.	Unit
$V_{RSM/DSM}$	max. non-repetitive reverse/forward blocking voltage	$T_{VJ} = 25^{\circ}C$			1900	V
$V_{RRM/DRM}$	max. repetitive reverse/forward blocking voltage	$T_{VJ} = 25^{\circ}C$			1800	V
I_{RD}	reverse current, drain current	$V_{R/D} = 1800 V$	$T_{VJ} = 25^{\circ}C$		50	μA
		$V_{R/D} = 1800 V$	$T_{VJ} = 125^{\circ}C$		10	mA
V_T	forward voltage drop	$I_T = 40 A$	$T_{VJ} = 25^{\circ}C$		1.33	V
		$I_T = 120 A$			1.70	V
		$I_T = 40 A$	$T_{VJ} = 125^{\circ}C$		1.36	V
		$I_T = 120 A$			1.88	V
I_{DAV}	bridge output current	$T_C = 80^{\circ}C$ rectangular $d = 1/3$	$T_{VJ} = 150^{\circ}C$		120	A
V_{T0}	threshold voltage	} for power loss calculation only	$T_{VJ} = 150^{\circ}C$		0.83	V
r_T	slope resistance				13.6	m Ω
R_{thJC}	thermal resistance junction to case				0.65	K/W
R_{thCH}	thermal resistance case to heatsink			0.1		K/W
P_{tot}	total power dissipation		$T_C = 25^{\circ}C$		190	W
I_{TSM}	max. forward surge current	$t = 10 ms; (50 Hz), sine$	$T_{VJ} = 45^{\circ}C$		500	A
		$t = 8,3 ms; (60 Hz), sine$	$V_R = 0 V$		540	A
		$t = 10 ms; (50 Hz), sine$	$T_{VJ} = 150^{\circ}C$		425	A
		$t = 8,3 ms; (60 Hz), sine$	$V_R = 0 V$		460	A
I^2t	value for fusing	$t = 10 ms; (50 Hz), sine$	$T_{VJ} = 45^{\circ}C$		1.25	kA ² s
		$t = 8,3 ms; (60 Hz), sine$	$V_R = 0 V$		1.22	kA ² s
		$t = 10 ms; (50 Hz), sine$	$T_{VJ} = 150^{\circ}C$		905	A ² s
		$t = 8,3 ms; (60 Hz), sine$	$V_R = 0 V$		880	A ² s
C_J	junction capacitance	$V_R = 400 V f = 1 MHz$	$T_{VJ} = 25^{\circ}C$		18	pF
P_{GM}	max. gate power dissipation	$t_p = 30 \mu s$	$T_C = 150^{\circ}C$		10	W
		$t_p = 300 \mu s$			5	W
P_{GAV}	average gate power dissipation				0.5	W
$(di/dt)_{cr}$	critical rate of rise of current	$T_{VJ} = 150^{\circ}C; f = 50 Hz$ repetitive, $I_T = 120 A$			100	A/ μs
		$t_p = 200 \mu s; di_G/dt = 0.45 A/\mu s;$ $I_G = 0.45 A; V = 2/3 V_{DRM}$ non-repet., $I_T = 40 A$			500	A/ μs
$(dv/dt)_{cr}$	critical rate of rise of voltage	$V = 2/3 V_{DRM}$ $R_{GK} = \infty; \text{method 1 (linear voltage rise)}$	$T_{VJ} = 150^{\circ}C$		1000	V/ μs
V_{GT}	gate trigger voltage	$V_D = 6 V$	$T_{VJ} = 25^{\circ}C$		1.4	V
			$T_{VJ} = -40^{\circ}C$		1.6	V
I_{GT}	gate trigger current	$V_D = 6 V$	$T_{VJ} = 25^{\circ}C$		70	mA
			$T_{VJ} = -40^{\circ}C$		150	mA
V_{GD}	gate non-trigger voltage	$V_D = 2/3 V_{DRM}$	$T_{VJ} = 150^{\circ}C$		0.2	V
I_{GD}	gate non-trigger current				5	mA
I_L	latching current	$t_p = 10 \mu s$	$T_{VJ} = 25^{\circ}C$		150	mA
		$I_G = 0.45 A; di_G/dt = 0.45 A/\mu s$				
I_H	holding current	$V_D = 6 V R_{GK} = \infty$	$T_{VJ} = 25^{\circ}C$		100	mA
t_{gd}	gate controlled delay time	$V_D = 1/2 V_{DRM}$ $I_G = 0.45 A; di_G/dt = 0.45 A/\mu s$	$T_{VJ} = 25^{\circ}C$		2	μs
t_q	turn-off time	$V_R = 100 V; I_T = 40 A; V = 2/3 V_{DRM}$ $di/dt = 10 A/\mu s dv/dt = 20 V/\mu s t_p = 200 \mu s$	$T_{VJ} = 125^{\circ}C$	500		μs



Package E2-Pack		Ratings				
Symbol	Definition	Conditions	min.	typ.	max.	Unit
I_{RMS}	RMS current	per terminal			50	A
T_{VJ}	virtual junction temperature		-40		150	°C
T_{op}	operation temperature		-40		125	°C
T_{stg}	storage temperature		-40		125	°C
Weight				176		g
M_D	mounting torque		3		6	Nm
$d_{Spp/App}$	creepage distance on surface / striking distance through air	terminal to terminal	6.0			mm
$d_{Spb/Apb}$		terminal to backside	12.0			mm
V_{ISOL}	isolation voltage	t = 1 second t = 1 minute 50/60 Hz, RMS; $I_{ISOL} \leq 1$ mA	3600			V
			3000			V

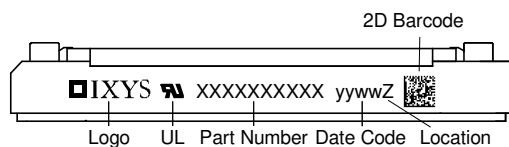

Part description

- M = Module
- C = Thyristor (SCR)
- M = Thyristor
- A = (up to 1800V)
- 120 = Current Rating [A]
- UJ = 3- Rectifier Bridge, half-controlled (high-side) + free wheeling Diode
- 1800 = Reverse Voltage [V]
- ED = E2-Pack

Ordering	Ordering Number	Marking on Product	Delivery Mode	Quantity	Code No.
Standard	MCMA120UJ1800ED	MCMA120UJ1800ED	Box	6	510125

Equivalent Circuits for Simulation

* on die level

$T_{VJ} = 150^{\circ}C$

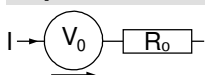

Thyristor

$V_{0\ max}$	threshold voltage	0.83	V
$R_{0\ max}$	slope resistance *	10.5	mΩ



Outlines E2-Pack

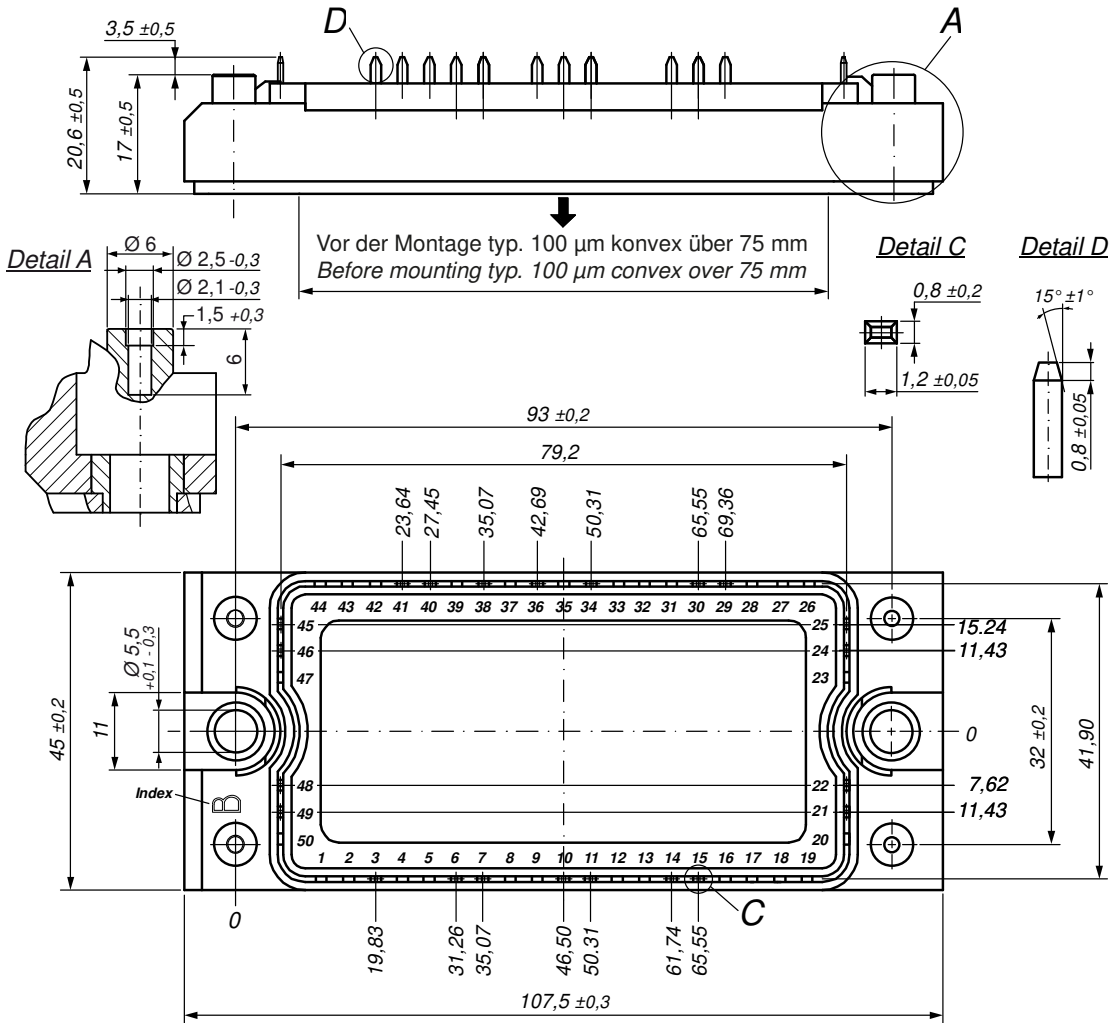

Bemerkung / Note:

- Nichttolerierete Maße nach / *Measure without tolerances according DIN ISO 2768-T1-m*
- PCB-Lochmuster / *PCB hole pattern: see pin position*
- Toleranz Pin-Position und PCB-Lochmuster / *Tolerance of pin position and PCB hole pattern: $\oplus 0.1$*
- Montageanleitung / *Mounting instruction: www.ixys.com Application note IXAN0024*

Detail A: PCB-Montage / *Mounting on PCB*

- Empfohlene, selbstschneidende Schraube / *Recommended, self-tapping screw: EJOT PT® (Größe / size: K25)*
- Max. Schraubenlänge / *Max. screw length: PCB-Dicke / thickness + 6 mm (max. Lochtiefe / hole depth)*
- Empfohlenes Drehmoment / *Recommended mounting torque: 1.5 Nm*

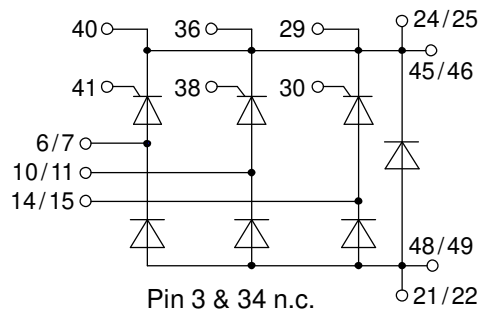

Thyristor

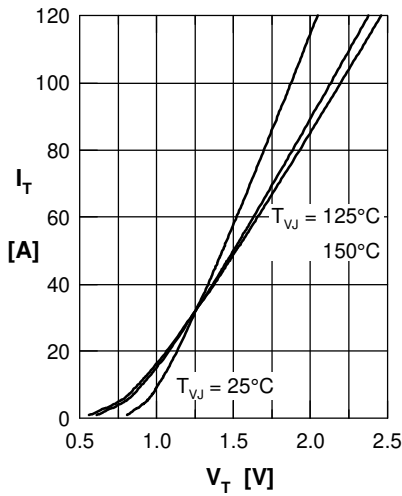

Fig. 1 Forward characteristics

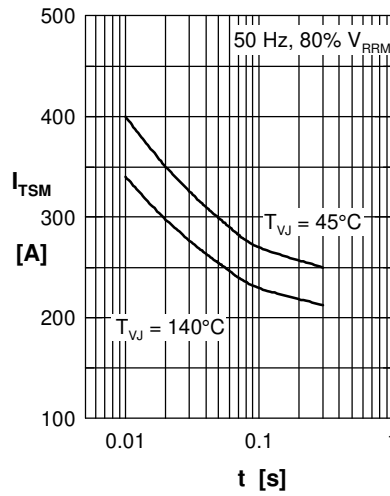

Fig. 2 Surge overload current
 I_{TSM} : crest value, t : duration

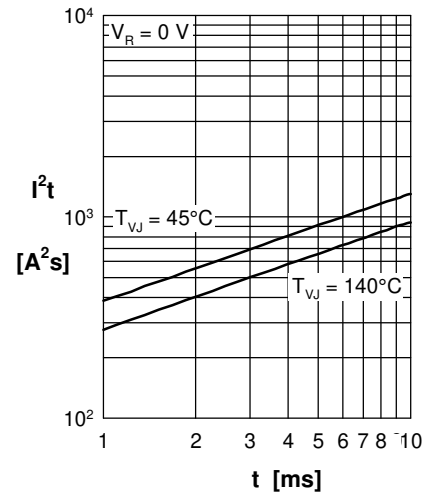

Fig. 3 I^2t versus time (1-10 s)

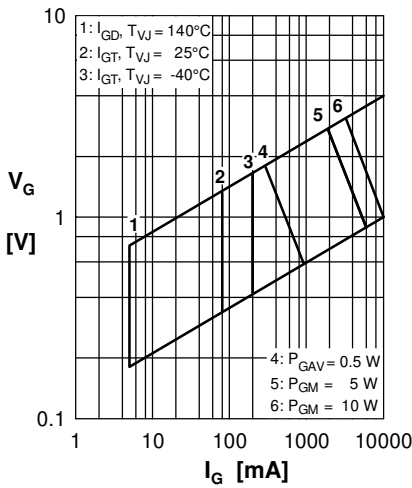

Fig. 4 Gate voltage & gate current

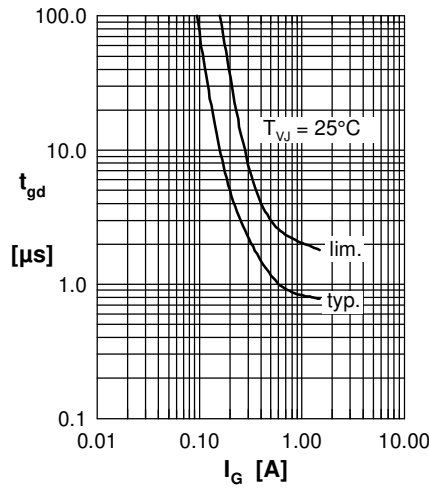

Fig. 5 Gate controlled delay time t_{gd}

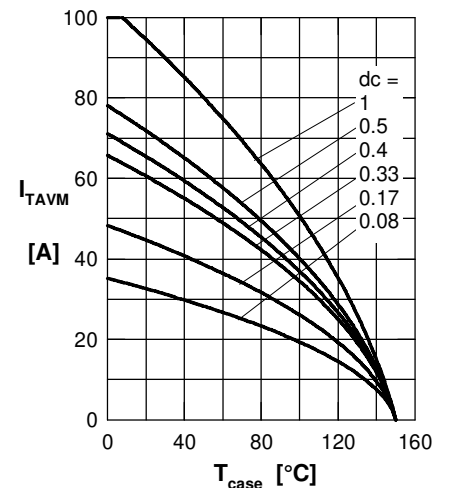

Fig. 6 Max. forward current at case temperature

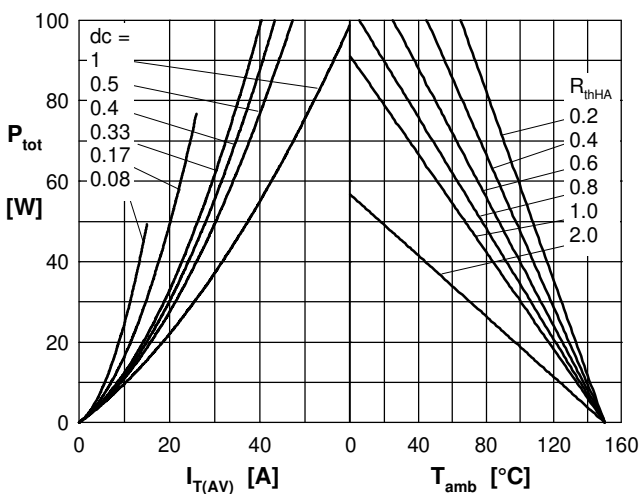

Fig. 7a Power dissipation versus direct output current
 Fig. 7b and ambient temperature

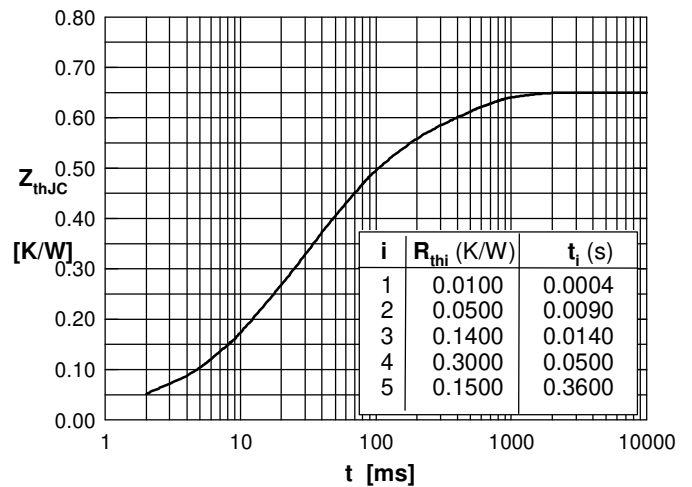

Fig. 8 Transient thermal impedance junction to case

Handling and Mounting Littelfuse Power Semiconductor Modules with Solid Metal Base Plates

Objectives

This application note discusses mounting and handling for Littelfuse power semiconductor modules with a backside that is formed by a solid metal base plate as depicted in Figure 1. Information is provided focusing on special precautions to be considered during mounting.

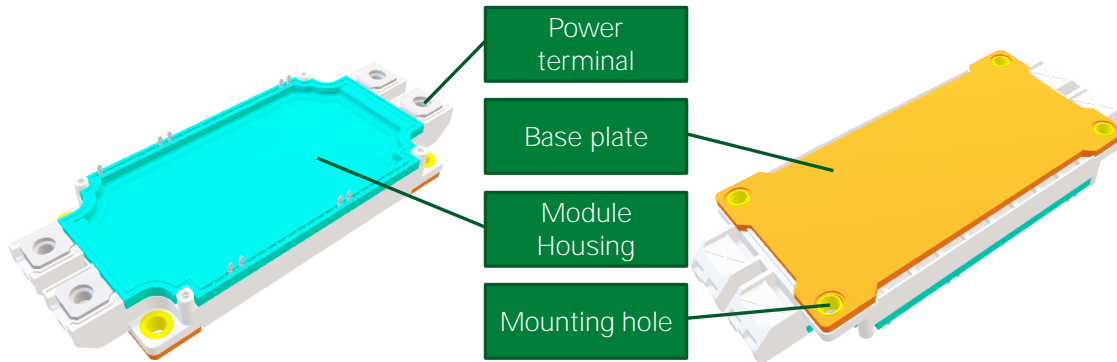

Figure 1: Littelfuse Simbus F Power Module, featuring a Solid Metal Base Plate

Applications

- Industrial motor drives
- PV inverters
- UPS systems
- DC-DC converters
- Commercial vehicles

Target Audience

This document is intended for potential adopters of power semiconductors who want to determine the appropriate mounting and cooling solution to ensure proper package mounting and thermal performance.

Contact Information

For more information on the topic of mounting this kind of devices, contact the Littelfuse Power Semiconductor team of product and applications experts:

- PowerSemiSupport@Littelfuse.com

Table of Contents

1. Introduction	4
2. Recommended Heat Sink Assembly	4
2.1. Heat Sink Preparation	5
2.2. Use of Thermal Interface Materials	5
2.3. Detailed Mounting Procedure.....	6
3. Further Mechanical Aspects.....	7
3.1. Metric Thread, Imperial Thread, Self-tapping Screws.....	7
3.2. Mounting the Electronics and DC-link Components.....	8
3.3. Design Verification.....	9
3.4. Insulation Management.....	9
4. Conclusion.....	10

List of Figures

Figure 1: Littelfuse Simbus F Power Module, featuring a Solid Metal Base Plate..... 1

Figure 2 Selection of Littelfuse Packages featuring Base Plates 4

Figure 3. Mounting the Module to a Heat Sink..... 4

Figure 4. Heat Sink’s Surface Requirements to Mount Power Modules 5

Figure 5. Improving Thermal Transfer by using Thermal Interface Material (TIM) 5

Figure 6: Bolting down the screw – Incorrect and Correct Method..... 6

Figure 7: Tightening Sequence for Modules with a 4-screw Arrangement 6

Figure 8: Phillips-style Screws and Captivated Washers according to ISO 10644 7

Figure 9: Module Assembly with Power-Terminals attached 8

Figure 10: Results from inspecting the Pressure Distribution using Color-changing Film 9

Figure 11: Piezo-electric, Tactile Pressure Sensor and the results captured 9

1. Introduction

A multitude of power semiconductors feature metal base plates that carry the internal structure made from direct copper bonded substrates that in turn carry the power semiconductors. The DCB substrate inherently offers electrical insulation and allows multiple semiconductor chips on one substrate to form different circuit topologies. Potting gel inside the plastic housing provides excellent sealing and semiconductor protection. The backside copper of the DCB substrate is connected to the base plate which acts as large-area interface between the semiconductor and a heat sink. An illustration of such packages is shown in Figure 2.

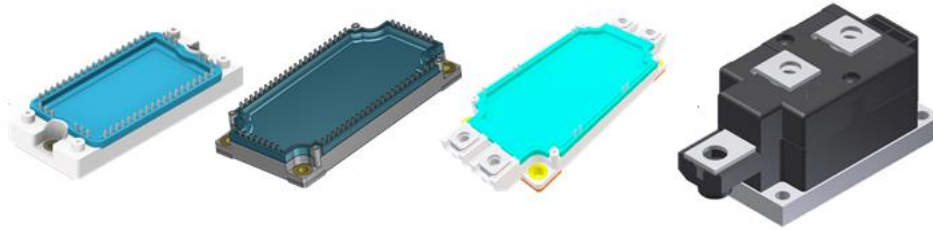

Figure 2 Selection of Littelfuse Packages featuring Base Plates

These packages provide unique features for power electronic applications. These include:

- High electric insulation strength
- High thermal performance
- Current ratings to support applications up to hundreds of kilowatts
- Internal construction is designed to reduce stray inductance and parasitic capacitances, leading to improved EMI-performance

2. Recommended Heat Sink Assembly

Semiconductor power modules are designed to be mounted onto a heat sink using screws. A layer of Thermal Interface Material (TIM) is needed to ensure a high thermal conductivity from the exposed DCB to the heatsink. After the TIM application is completed, the module can be mounted to a heatsink by mounting screws. An example of module and assembly is sketched in Figure 3.

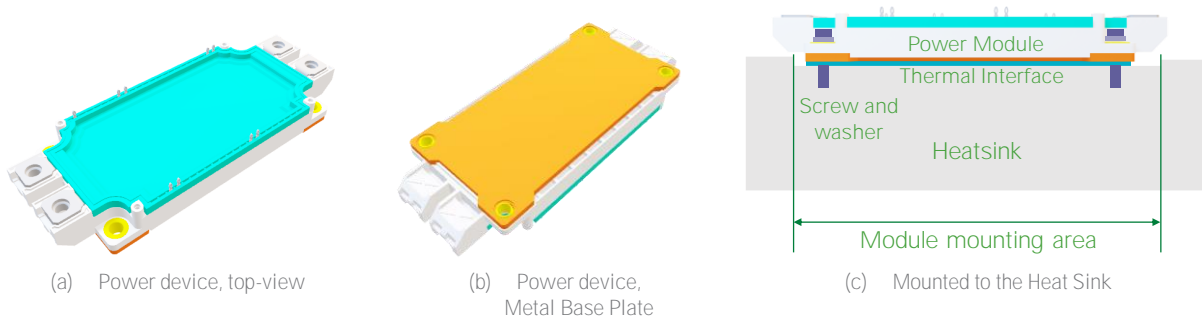

Figure 3. Mounting the Module to a Heat Sink

2.1. Heat Sink Preparation

When the package is mounted, the base becomes the crucial surface for thermal management. A heatsink needs to be mounted for heat dissipation, as depicted in Figure 3. There are dedicated mounting holes in packages — the proper set of dimensions is given in the correlating datasheet.

To ensure a low value of thermal resistance, the contact surface of the heat sink must be flat, even, and clean. For the mounting area, the surface quality must achieve or exceed the values given in Figure 4.

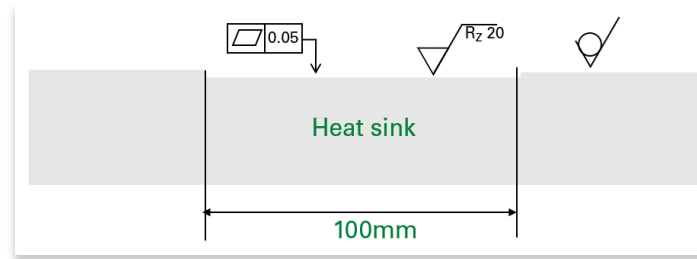

Figure 4. Heat Sink's Surface Requirements to Mount Power Modules

Prior to mounting, cleaning all surfaces with a suitable cleaning agent is advised.

2.2. Use of Thermal Interface Materials

The use of Thermal Interface Materials (TIM) is mandatory to achieve a suitable contact between the device's base and the heat sink surface. It reduces the thermal resistance case-to-heatsink, R_{thch} . Thermal interface materials are available as thermal pad and thermal grease or compound. Unlike the discrete packages where the copper cooling pad is usually electrically active, packages with solid metal base plates internally feature a DCB structure which uses a layer of ceramic as electrical isolation. With up to 4500 V isolation voltage, the packages provide the option to use electrically non-isolated thermal interface materials. It is not recommended to use an interface material with isolation such as silicone-pads sometimes used for discrete packaged devices. These materials inherently exhibit a higher thermal resistance compared to thermal greases or conductive thermal pads.

The thermal interface materials should be applied evenly to the device base plate or the heat sink surface. Ideally, screen printing is used to achieve accurate and reproduceable results. A screen thickness of 100 μm with a fill-factor of 70-80% and a regular pattern of honeycomb-shaped openings has proven to be a reasonable approach.

As no electrical isolation is required from the TIM layer, it is recommended to have a very thin layer of TIM so that the material just fills the gaps and voids between the device's copper pad and the heatsink, as seen in Figure 5.

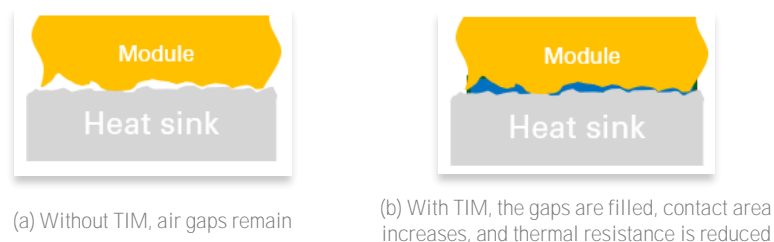

Figure 5. Improving Thermal Transfer by using Thermal Interface Material (TIM)

If a solid thermal pad is considered, softer materials with high thermal conductivity are preferred to better fill the gaps. The thermal pad should be as thin as possible to provide the lowest thermal resistance. The mounting mechanism using screws provides proper pressure on the thermal interface material to ensure a low value of thermal resistance.

A procedure listing how to create a proper stencil and set up a basic stencil-printing equipment is described in detail in the application note *Basics of Stencil Generation to Apply Thermal Grease to Power Semiconductors*, which can be downloaded from the Littelfuse website.

2.3. Detailed Mounting Procedure

Mounting the module by screws inherently achieves mounting forces in a range of kilonewton. Though the base plate is highly resistant to pressure, the internal DCB-structure is very sensitive towards bending. Therefore, careful handling and step-by-step tightening of the screws is mandatory to achieve the desired pressure distribution and prevent bending the internal DCB.

Besides the mounting forces, an even distribution of thermal interface material is important. Uneven distribution, particularly with higher amount of material in the center of the module, may also lead to high local forces that could damage the DCB inside the power module. Using solid sheets as thermal interface material is not a recommended solution as these typically remain too thick and limit the module's thermal performance. Additionally, they may lead to further issues during mounting.

Figure 6 illustrates that the module lifts on one side in case the first screw is bolted down too much, and a two-step sequence to prevent this from happening.

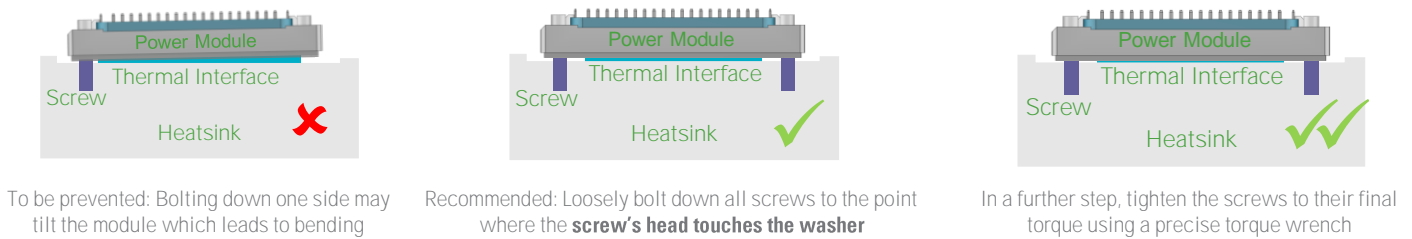

Figure 6: Bolting down the screw – Incorrect and Correct Method

Depending on the package, either two or four screws need to be tightened. In case of two screws, tightening takes place in an alternating manner. For four screws, the sequence given in Figure 7 needs to be followed.

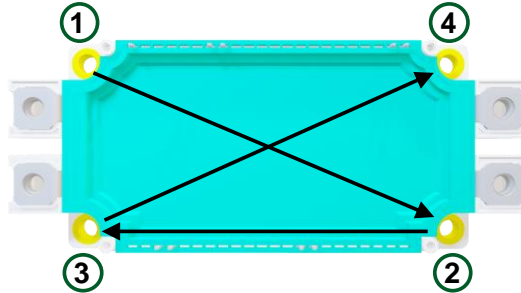

Figure 7: Tightening Sequence for Modules with a 4-screw Arrangement

For the package types with two and four screw positions, the tightening procedure is summarized in Table 1.

Table 1: Mounting Sequence for Y-Packages with exposed DVB

Package type	Screw diameter	Step 1	Step 3	Step 4	Step 5
2 screws	5 mm	Bolt down all screws, so that the screws' head touches the washer	Apply 0.5 Nm to both screws	Wait for the assembly to settle. Settling time depends on the TIM in use and varies from 5-10 minutes	Apply 3 to 6 Nm to both screws
4 screws	5 mm		Apply 0.5 Nm to all screws		Apply 3 to 6 Nm to all screws

In case imperial screws are preferred for mounting, a screw 10-32 is the closest replacement for M5.

3. Further Mechanical Aspects

Besides the data and procedures to mount power electronic components, influences that arise from mechanical parts and physics need detailed attention. Some details that appear to be of minor impact can lead to unexpected effects with highly detrimental consequences.

3.1. Metric Thread, Imperial Thread, Self-tapping Screws

The recommended material for mounting the module to the heat sink is a metric screw with spring-washer and captivated washer as described by ISO 10644. Zinc- or nickel-plated steel screws with a property class 6.8 or higher as depicted in Figure 8 are recommended.



Figure 8: Phillips-style Screws and Captivated Washers according to ISO 10644

Using screws with imperial scale is an option too. However, due to the different diameters and thread's pitch, the ratio between turning angle, torque, and resulting mounting forces also changes. Purely translating newton meter (Nm) into pound inches (lb-in) might result in misleading values. Individual verification of the result is advised to verify proper pressure and pressure distribution is achieved.

In case self-tapping screws like those described in DIN7504-K and ISO15480 are preferred, dedicated tests are needed to correlate torque, turning angle, and mounting force. As the torque mainly depends on the drill-hole's diameter and the heat sink material, no general recommendation can be made. Using washers and spring-washers in combination with self-tapping screws is advised.

3.2. Mounting the Electronics and DC-link Components

Power modules are robust regarding pressure applied, but highly sensitive towards pulling forces. Pulling forces can be a consequence of dynamic influences like shock and vibration but as well result from the combination of materials used in the construction and their tolerances.

A mechanical assembly must ensure that the resulting forces to the terminals remain directed as pictured in Figure 9.

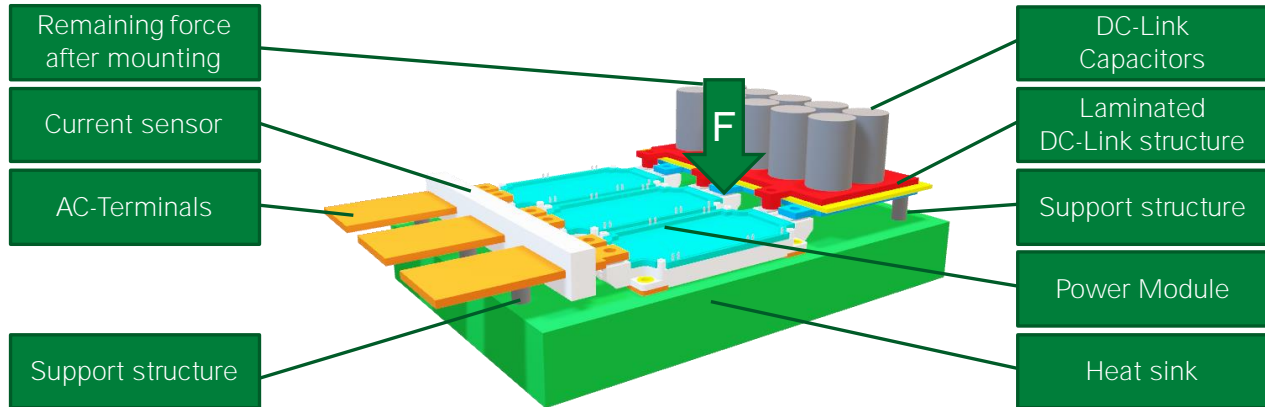

Figure 9: Module Assembly with Power-Terminals attached

A total force of up to 100 N applying pressure to the module is tolerable while no pulling force may remain after mounting is complete. To achieve this, properly dimensioned supports must be installed. These prevent static forces as well as dynamic events from reaching the terminals. Including all tolerances, the supports' length needs to remain below the height of the module in use.

As can be seen in Figure 9, larger components like DC-link capacitors, output terminals, or heavy current sensors demand additional support. In case of vibration, undamped oscillating masses may inject destructive forces into the power component.

To mount the DC-link-structure to the modules, either as PCB or laminated copper plates, the screws mandatorily need to comply with the information given in the data sheet. The maximum length of the screws depends on the thickness of the structure mounted on top of the modules. Caution is advised as too long screws can damage the housing, enter electrically sensitive areas, and cause severe damage.

As the nuts embedded in the modules feature metric threads, the use of screws according to imperial scale is not an option for mounting the power terminals. The nuts are held in place by the module's housing. Applying too high torque can lead to damage of the housing and in turn to loss of function. Especially in combination with oils used to prevent corrosion, the friction during mounting can change massively, leading to a distortion in the ratio of torque and turning angle. The same applies when using adhesive-based thread lockers.

When handling subassemblies, supporting the whole setup while moving it is recommended. Using the bus bar or the PCB as a handle carries a high risk of applying pulling forces and therefore needs to be prevented.

If a module is being replaced, ensure there is no contamination in the threaded hole — for example, thermal paste that has been solvent washed into the threads — as this may limit the screws' engagement, resulting in false fastener tension and module clamping force. In situations where blind holes are not required for maintaining corrosion or pressure sealing performance, threaded through holes can be used as these can be brushed, washed clean, and inspected easily.

3.3. Design Verification

To verify the mounting procedure during the design phase, monitoring the pressure distribution on the module-area is recommended.

Littelfuse recommends the use of Fuji Prescale film or a similar film product to confirm the pressure uniformity. These films are available in several different pressure ranges and should be inserted between the semiconductor device and the heat sink prior to mounting.

Once pressure is applied to an area of the film, the material irreversibly changes color to indicate the local pressure. The pressure distribution achieved with a given setup can be judged by disassembling the module and inspect the film. Uniform color change signals uniform pressure. A suitable pressure distribution and a non-uniform result, achieved on a circular device, are summarized in Figure 10 respectively.

The second option is given by using pressure sensitive electrical sensor arrays. These consist of a matrix of pressure-sensitive resistors that can be measured by dedicated equipment. The result is displayed as a color-map. In contrast to the irreversible color change of the film, these sensors allow monitoring in real-time and can be reused. A common sensor and a typical result from such a measurement is included in Figure 11.



Figure 10: Results from inspecting the Pressure Distribution using Color-changing Film

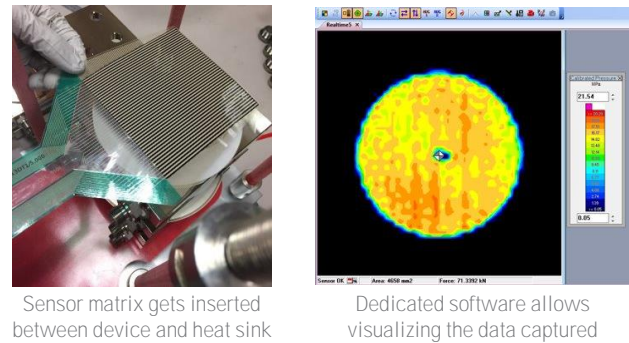

Figure 11: Piezo-electric, Tactile Pressure Sensor and the results captured

This verification only targets monitoring the mounting procedure and should be done without thermal interface material attached to the base of the semiconductor component to prevent contamination of the sensor’s surface.

Both the sensor types need to be removed from the setup afterwards. The result demonstrated by the measurement can substantiate that the chosen assembly technique reproducibly leads to the correct magnitude of force as well as to beneficial pressure distribution.

3.4. Insulation Management

Two major parameters require to be considered when PCB-layouts and DC-link-components are designed:

- Clearance – the shortest possible distance between two points, and
- Creepage distance – the shortest path from one point to another point along an uninterrupted line on solid material

Particularly when using laminated bus bar structures, isolating the layers from each other remains an important task.

In high-voltage environments, arcing between different voltage levels must be prevented. Arcing takes place over air-gaps – clearance distances – so the voltage level expected in the final system defines the distance between pads and traces as well as between active areas and heat sinks or other grounded parts. Even if the clearance between two points is chosen to be high enough, the insulation strength can be reduced by conductive particles over a longer period. This depends on the degree of pollution, which relates to the ambient conditions the device is used in.

IEC60664-1 gives an insight about the relevant conditions that need to be considered to determine the creepage and clearance distances in a targeted design.

4. Conclusion

Packages with a solid base plate are less challenging in mounting than devices that feature exposed DCBs. Still, care needs to be taken to not bend the module during the process and a mechanical arrangement is designed to prevent pulling forces at the terminals. Applying thermal interface material by a well-controlled screen-printing process further helps to reduce unwanted mechanical stress to the device.

If these aspects are considered, mounting the devices can successfully be done by implementing established procedures and processes.

Revision History		
Version	Date	Changes
22.08a	August 2022	Initial version created for release

For additional information please visit www.Littelfuse.com/powersemi

Disclaimer Notice - This document is provided by Littelfuse, Inc. ("Littelfuse") for informational and guideline purposes only. Littelfuse assumes no liability for errors or omissions in this document or for any of the information contained herein. Information is provided on an "as is" and "with all faults" basis for evaluation purposes only. Applications described are for illustrative purposes only and Littelfuse makes no representation that such applications will be suitable for the customer's specific use without further testing or modification. Littelfuse expressly disclaims all warranties, whether express, implied or statutory, including but not limited to the implied warranties of merchantability and fitness for a particular purpose, and non-infringement. It is the customer's sole responsibility to determine suitability for a particular system or use based on their own performance criteria, conditions, specific application, compatibility with other components, and environmental conditions. Customers must independently provide appropriate design and operating safeguards to minimize any risks associated with their applications and products.

Littelfuse products are not designed for, and shall not be used for, any purpose (including, without limitation, automotive, military, aerospace, medical, life-saving, life-sustaining or nuclear facility applications, devices intended for surgical implant into the body, or any other application in which the failure or lack of desired operation of the product may result in personal injury, death, or property damage) other than those expressly forth in applicable Littelfuse product documentation. Littelfuse shall not be liable for any claims or damages arising out of products used in applications not expressly intended by Littelfuse as set forth in applicable Littelfuse documentation.

Read complete Disclaimer Notice at www.littelfuse.com/disclaimer-electronics