



### PURPOSE

Current sense transformers are used to detect high frequency currents, in order to protect an electronic switch against overcurrents in switching converters. They are typically connected to the primary side of power high frequency transformers, but they are furthermore suitable for current measurements, in applications which don't require high accuracy, but rather prompt response of the measurement equipment.

### FEATURES

These current sense transformers are developed to detect alternate currents from 20 to 50 A, in the frequency range of some kHz. By connecting a burden resistance to the secondary side, you can read a proportional voltage signal, isolated from the mains but, depending on the application, other different signal processing are possible, whether by using digital or analogue techniques. Those current transformers can be built with any turns ratio, depending on what the application requires, but the most typical ratios are the following ones: 1:50, 1:100, 1:200, 1:500, 1:1000.

As the number of turns increases, the optimum working frequency range moves towards low frequencies. The minimum working frequency is related to the capability of the core to transfer the current pulse (see the transfer area value).

The burden resistance sets the output voltage range, so after the developer has chosen the signal level, the minimum working frequency is fixed and for higher frequencies the detection circuit will not show any signal distortion. The maximum working frequency is influenced mainly by two factors: the core material behaviour versus frequency and the secondary intrawinding capacity, that limitate the current transformer bandwidth.

From building point of view, high frequency current transformers can be wound both on toroidal cores or on E cores.

Linear models, based on E cores, are available exclusively with the primary turn inside, so they are especially recommended for control functions in equipments where the low cost is achieved by simply, safe and easy-mounting components.

The table shows some of our most wanted high frequency current transformers.

Code	$I_p$ [Arms]	n	$L_s$ [mH]	$f_{max}$ [kHz]	$V_t$ [ $\mu$ Vs]	Drawing	D [mm]	$U_{is}$ [Vrms]	$U_p$ [Vrms]
TA 150511	20	(1) : 50	1,9	1000	180	1508FA	5	1000	4500
TA 150512	20	(1) : 100	7,5	400	400	1508FA	5	1000	4500
TA 150513	20	(1) : 200	30	100	850	1508FA	5	1000	4500
TA 150521	20	(1) : 50	4,5	500	160	1508FA	5	1000	4500
TA 150522	20	(1) : 100	19	200	360	1508FA	5	1000	4500
TA 150523	20	(1) : 200	76	50	750	1508FA	5	1000	4500
TA 150524	20	(1) : 500	475	10	1800	1508FA	5	1000	4500
TA 150320	25	(1) : 200	100	80	500	150320	6	750	3500
TA 150563	25	(1) : 1000	5000	10	2500	1508FB	6	750	4000
TA 150621	20	1 : 100	10	100	550	15062X	1,2	440	4000
TA 150622	20	1 : 200	40	50	1100	15062X	1,2	440	4000
TA 150625	20	1 : 1000	1000	10	6000	15062X	1,2	440	4000
TA 150641	50	1 : 100	10	100	850	15064X	2,3	480	4680
TA 150642	50	1 : 200	40	50	1900	15064X	2,3	480	4680
TA 150645	50	1 : 1000	1000	10	9000	15064X	2,3	480	4680

### SYMBOLS:

- n turns ratio
- $R_s$  secondary winding resistance
- $I_p$  rated primary current (rms value)
- $L_s$  rated secondary inductance
- $f_{max}$  recommended maximum working frequency
- $V_t$  secondary transfer area at 25°C
- $U_{is}$  maximum working voltage primary/secondary
- $U_p$  isolation voltage primary/secondary
- D central hole diameter/primary turn diameter

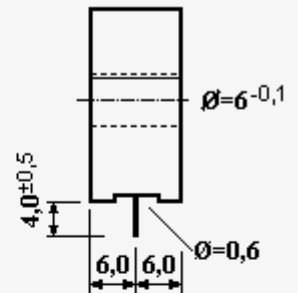
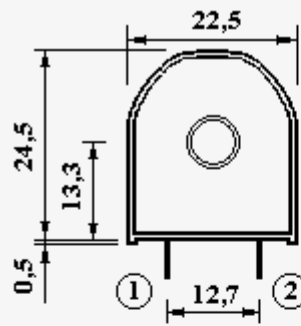
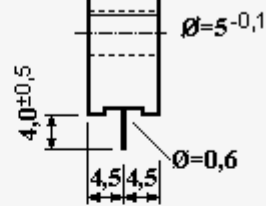
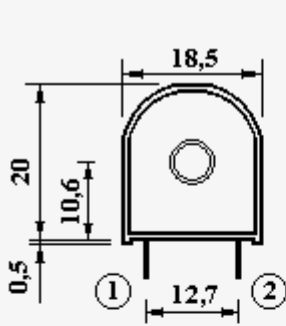

1508FA

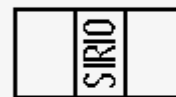

1508FB

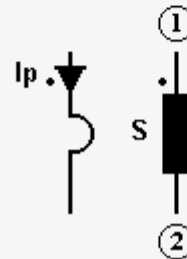
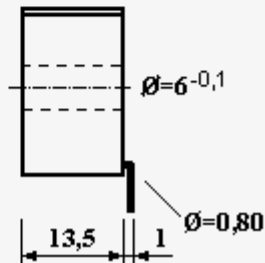
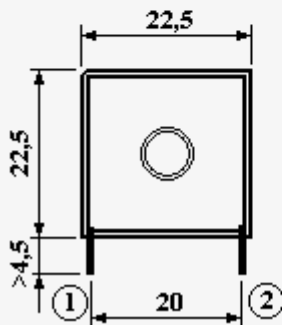

150320

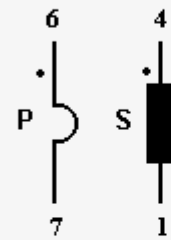
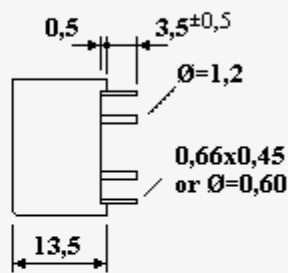
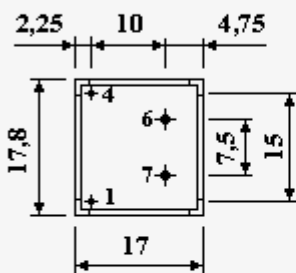

15062X

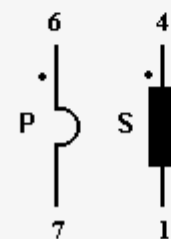
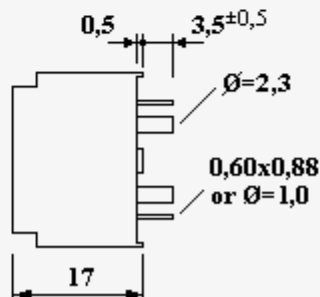
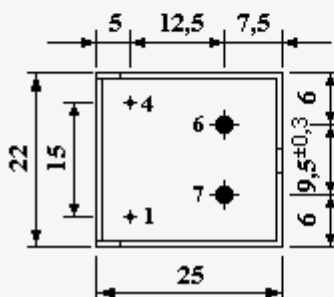

15064X

values in mm

TA05 - Rev.0



Certificate nr. 50 100 3372



SIRIO ELETTRONICA s.r.l.

Via Selve, 2 - 35037 TEOLO (PD) - ITALY

Phone: 0039 049 9901090

Fax: 0039 049 9901868

E-mail: [postoffice@sirio-ic.com](mailto:postoffice@sirio-ic.com)

[www.sirio-ic.com](http://www.sirio-ic.com)